



Strategic Plan for Sustainability

December 15, 2010

Submitted by:



Gary Walby, Ph.D.
Senior Evaluator
Research, Evaluation and Systems

Zach Summerlin, M.S.W.
Research, Evaluation and Systems



Sponsored by the United States Department of Health and Human Services, Administration on Developmental Disabilities and the Florida Developmental Disabilities Council, Inc.

Acknowledgments

We would like to thank the Florida Developmental Disabilities Council, the Early Steps State Office, all local Early Steps directors, coordinators and staff, and the many parents, providers, and stakeholders that participated in this process. The Florida Developmental Disabilities Council provided the funding and vision for this project and their foresight will do much in maintaining Early Steps as a key component for serving the youngest and most vulnerable of Florida's children. The dedication and selflessness of all partners to make this process successful has surpassed our hopes and contributed greatly to the quality of this work.



Table of Contents

Executive Summary.....	i
Introduction	1
<i>History and Background of Early Steps</i>	2
<i>Purpose, Goal and Mission of Early Steps</i>	3
Challenges Early Steps Faces.....	3
<i>Funding and Budgetary Challenges</i>	3
<i>Cost Inefficiencies</i>	4
<i>Lack of Knowledge and Awareness</i>	4
Critical Success Factors	5
<i>Revenue Streams</i>	5
<i>Cost-Efficiency</i>	5
<i>Visibility of the Program</i>	5
<i>Recruitment and Retention</i>	6
Priority Listing of Strategies	6
<i>Tier 1 Strategies</i>	7
<i>Tier 2 Strategies</i>	7
<i>Tier 3 Strategies</i>	8
<i>Tier 4 Strategies</i>	9
Strategy Description and Action Steps.....	10
<i>Tier 1 Strategies</i>	11
<i>Tier 2 Strategies</i>	17
<i>Tier 3 Strategies</i>	25
<i>Tier 4 Strategies</i>	34
Strategic Planning and Implementation as a System Approach	38
Primary Relationships between Strategies	38
Implementation Elements	45
<i>Resistance to Change</i>	45
<i>Poorly Coordinated or Minimal Implementation Effort</i>	46
<i>Implementing Strategies</i>	46
<i>Monitoring and Reporting on Implementation</i>	47
Review of Strategic Planning Activities	47
<i>Original Data Collection Methods</i>	49
<i>Additional Data Collection Methods</i>	52
<i>Analytic Process</i>	52
<i>Interim Documents</i>	53

Early Steps Strategic Plan for Sustainability

Executive Summary

The Early Steps State Office (ESSO), local early steps (LES) offices, the Florida Developmental Disabilities Council (FDDC) and the Ounce of Prevention Fund of Florida (OPFF) collaborated over an eight-month period to develop a strategic plan for the sustainability of Early Steps. Early Steps serves children up to three years of age with developmental disorders or delays and their families. Early Steps receives and administers Part C dollars and uses a service delivery approach (team-based primary service provider [TBPSP]) consistent with federal requirements for the Part C program. Early Steps must target four overarching critical factors to successfully meet the challenge of sustainability:

1. Solidify existing revenue streams and find additional revenue streams.
2. Improve cost efficiency of program- service provision.
3. Increase visibility of the program to divergent stakeholders.
4. Improve policies and operations to increase recruitment and retention of quality providers.

In the last five fiscal years, Early Steps has served an average of 40,316 children per year. Since the 1994-95 fiscal year, the number of children served has more than doubled, reflecting greater need, better identification, and more awareness of developmental issues due, in a large degree, to the impact of autism awareness efforts. The state of Florida's 2009-2010 investment of \$ 23,137,612 in the Early Steps program leveraged \$ 23,218,548 in Part C federal funds to provide Early Steps services to children with developmental issues. The recent National Early Intervention Longitudinal Study (NEILS) demonstrates an improvement in general health, improved functioning, and decreased need for special education services for children that receive Early Intervention services. This translates into dollars saved due to a reduction in the need for costly medical care and the substantially lower cost of regular versus special education services.

Multiple methods and analytic techniques were used to collect and assess information on potential sustainability strategies and then reduce them to a manageable number that targeted all critical areas without redundancy. The initial 623 strategies were reduced to 40 strategies that in total address the four critical factors just noted. The final 40 strategies were placed into four tiers. The first tier contains the seven most critical strategies plus an additional strategy detected early and implemented immediately to address the need for a systematic public relations campaign. These eight initial strategies are:

1. Develop a definitive definition of the TBPSP approach for Florida while clarifying and strengthening state policy requiring the use of the TBPSP model for service delivery.
2. Provide support for local creative partnerships for resource development, e.g. fund-raising.
3. Increase the level of reimbursement for Medicaid, Medicaid HMOs and Part C providers to better recruit and retain quality providers.
4. Reduce Service Coordinator caseloads.

5. Obtain evidence of effectiveness and return on investment (ROI) specific to Early Steps and its implementation of the TBPSP model .
6. Standardize, systematize and provide greater state level support for travel, as this is a major cost as well as a barrier for providing services in line with the TBPSP model .
7. Investigate the practices and processes of LES offices that are routinely coming in on or under budget so they can be shared statewide, then develop a plan for sharing and evaluating across the state.
8. Additional: Develop, complete and evaluate a targeted public relations campaign to increase awareness of Early Steps among key stakeholder groups including the Florida Legislature and other policy/funding entities, referring entities and organizations (e.g. pediatricians), local and state-level service provider organizations, communities and families.

The planning process was far- reaching, team- oriented, and included two stakeholder groups. Stakeholder Group 1 (the Early Steps Stakeholder Workgroup) was required by the FDDC. A small number of individuals were identified and, following discussions between OPFF, ESSO and the FDDC, other members were identified until a comprehensive group of 26 professionals was selected and agreed to serve. Stakeholder Group 2 was comprised of the LES directors/coordinators and select designees from each site. Stakeholder Group 2 was essential in keeping the process grounded in the local needs and context in which each LES works.

Action steps for the 40 strategies were developed during a two-day, face-to-face meeting with Stakeholder Group 1 and then refined collaboratively with the OPFF development team. The action steps for each strategy are contained in the larger plan and are not presented here.(where can one find them?) A review of action steps resulted in bulleted lists with action steps placed in a logical but not absolute order for implementation. Thus, action steps are not numbered, as it is expected that the order may change when implementation reveals additional information that needs to be considered and it is likely that some action steps will be executed simultaneously.

Because of the systems- based analytic process, it is important to consider the interdependence of the strategies. A common failing in writing and then implementing a strategic plan is losing sight of the whole while focusing on the specifics of the plan. The strategies in this plan will likely be implemented systematically a few at a time for the sake of convenience. Since working on one strategy will likely impact several other strategies, it is important to remain conscious of the overall plan. The potential cross- strategy impact is difficult to anticipate and will result in unexpected, positive consequences as well as negative effects.

Implementing the plan will be a challenge. Resistance to change and a poorly coordinated or minimal implementation effort will adversely influence the overall effect of the plan. Although implementation is beyond the scope of the strategic plan, the strategic plan does include some suggestions for implementation. The following are the most vital suggestions for implementation:

- Convene an implementation team to monitor, assist and/or actively participate in implementing the strategies in this plan.
- Ensure that the 'three C's' of strategic planning are present: commitment, credibility (which has hopefully started with the transparent planning process) and communication.

- Require commitment by the leadership of ESSO and the LES that should be consistently modeled to all members of the team as well as other participants.
- Earn continued credibility through representative participation, adherence to the plan, and clear documentation.
- Develop active and clear communication with adequate feedback pathways as one mechanism to guarantee that the process is transparent and understood by all participants.
- Provide progress updates and insist on accountability from implementation team members.
- Set up a monitoring system that has a central person or persons that are responsible for tracking tasks, timeframes, and other key factors to inform leadership when delays or other issues arise.
- Meet regularly, according to an agreed- upon timeframe, to discuss progress and make recommendations for redirecting resources, assisting members in need, or making other changes.
- Make sure that an ‘early warning’ system is in place and operational to detect misuse or waste of resources, or delays in completion large enough to threaten the process or team morale.

Multiple methods were important to the development of the strategic plan and were used to collect, analyze and reduce the data to the final 40 strategies. Original methods used included:

- Synthesis of state and local Early Steps documents
- Synthesis of documents from 12 other states
- Interviews with the directors from 12 other states
- Interviews with parents, providers and stakeholders (15 total)
- Serial focus groups with LES directors (3 rounds, 4 focus groups/round, 12 total)
- On-site focus groups with family members, providers and stakeholders (4 each, 12 total)
- Relevance and sustainability survey to rate the final 40 strategies

Additional methods added:

- Director survey of the 15 LES regions
- Provider open and closed question online survey (583 respondents)
- Parent open and closed question online survey (210 respondents)
- Additional interviews with key stakeholders and providers (19 respondents)
- Focus groups with LES service coordinators (4 total)
- Analysis of potential public relations campaign methods and content

Placement of strategies in tiers was based on a mixed- methods analytic approach to objectively identify a hierarchy of strategies based on importance to sustainability. Five equally weighted scales were combined to generate an overall rating that was then sorted from largest to smallest. Each scale was a six-point scale, with larger numbers meaning more of the attribute. Thus, the possible range was 5 to 30. The larger the number, the more important the strategy is for strategic sustainability. The five scales were:

1. The amount and quality of narrative data that supports inclusion of the strategy in the final 40

2. The amount and quality of narrative data that supports how central the strategy is anticipated to be for improving cost efficiency, revenue generation or service provision
3. The relevance rating of each strategy calculated by averaging the scores from the 56 respondents to the relevance and feasibility survey described in the body of this paper
4. The feasibility rating of each strategy calculated by averaging the scores from the 56 respondents to the relevance and feasibility survey described below
5. The degree of linkage to other strategies, in other words, how important the strategy is in support of, or being supported by, other strategies

The result of the analysis found natural separations between numbers that resulted in four tiers of strategies that clustered from high to low in importance to sustainability. The first tier is reproduced above on page i of the executive summary. The three remaining tiers should be implemented in order after, or near the completion of tier 1 strategies. Together, there is high confidence that implementing this strategic plan will have the desired effect of improving Early Steps sustainability.

Early Steps Strategic Plan for Sustainability

Introduction

Early Steps provides an essential service to some of Florida's most vulnerable children. Children with developmental delays or disorders face more barriers and longer roads to independence and success. Early intervention for children with developmental issues helps to improve their ability to communicate with and benefit from interactions with parents, siblings, and other children.

In the last five fiscal years, Early Steps has served an average of 40,316 children each year. Since the 1994-95 fiscal year, the number of children served has more than doubled, reflecting greater need, better identification, and more awareness of developmental issues due, in a large degree, to the impact of autism awareness efforts. The use of federal Part C dollars to fund developmental services results in a substantial savings for Medicaid and other state dollars and provides an important fiscal incentive to maintain the Early Steps program. The recent National Early Intervention Longitudinal Study (NEILS) demonstrates an improvement in general health, improved functioning and decreased need for special education services for children that receive Early Intervention services. This translates into dollars saved due to a reduction in the need for costly medical care and the substantially lower costs of regular versus special education services.

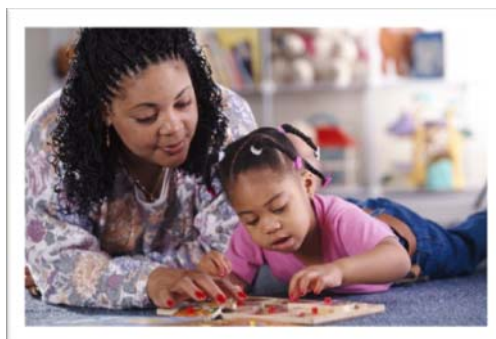

The system in place to help children with developmental issues and the families that love and provide for them, specifically the Early Steps program, is threatened. Early Steps is facing funding shortfalls due, in part, to the economic downturn coupled with identification of a larger number of children in need of services. The Early Steps State Office (ESSO), Local Early Steps (LES) and other stakeholders recognize the challenge they are facing and have responded with great concern for the children and families that could be left without recourse if born with autism, cerebral palsy, Down syndrome, or many other established conditions. For those parents watching their child fall behind and *not* having an established condition to explain what is happening, the fear and concern can be even greater. The types and intensities of developmental issues are sufficiently far-reaching that not all conditions have been identified. Early Steps operates in this world of fear and uncertainty daily as they make a difference for literally thousands of Florida's children.

To proactively address the eminent threat to Early Steps, the Florida Developmental Disabilities Council contracted with the Ounce of Prevention Fund to facilitate a strategic planning process and develop a viable plan for the sustainability of the Early Steps program. Early Steps is a team-based approach to providing services, so it is not surprising that representatives at the ESSO and the LES regions enthusiastically embraced a collaborative planning process and team approach to developing the sustainability plan.

Understanding the Early Steps Strategic Plan for Sustainability requires some knowledge of the history and background of Early Steps, its purpose, mission, goals, and critical factors for success, as well as the

challenges Early Steps faces. Following an overview of these preliminary areas, this report will present specific strategies, action steps, and implementation elements of the sustainability plan. Finally, the research activities undertaken to generate this plan will be reviewed.

History and Background of Early Steps

In 1974, 10 regional perinatal intensive care center programs were started in Florida to provide developmental evaluation and follow-up for babies who had received intensive care in specialized hospital settings including Neonatal Intensive Care Units (NICU). In the mid 1980s, the intensive care center programs became known as the Developmental Evaluation and Intervention (DEI) program. The program that would later become Early Steps began in Florida in September 1993 as the Infants and Toddlers Early Intervention Program and was placed with the DEI program. In July 2004, Florida began enhancing its existing service delivery system to better support infants, toddlers, and their families where they live, learn and play. At that time, the name of the program was changed to Early Steps. This improved service delivery system emphasized supporting children and families in the home, in early care and education centers, and in community settings where children experience everyday activities. Thus, children have the opportunity to engage with other children with developmental delays, as well as children that are progressing normally, in typical interactions that facilitate learning.

Early Steps continues to offer early intervention services to infants and toddlers (birth to thirty-six



months of age) with significant developmental delays or an established condition likely to result in a delay. The program is administered by Children’s Medical Services within Florida’s Department of Health. Currently, there are 15 local Early Steps offices, contracted through community-based organizations across the state of Florida, that administer Early Steps at the local level. The Early Steps system is based on the following policy and support components: the Developmental Evaluation Program (DEI), the Individuals with Disabilities Education Act (IDEA) Part C Program, and services provided under Chapter 393 Florida

Statutes (F.S. 393) for children birth to thirty-six months.

Infants eligible for the DEI Program component are those born or transferred into NICU and identified as at-risk for developmental disabilities within five days of admission or stabilization, as well as being Medicaid eligible. The DEI component of Early Steps provides hospital discharge planning, developmental surveillance, parent support and training.

The goal of the IDEA Part C component of Early Steps, which encompasses services under F.S. 393 for children birth to thirty-six months, is to ensure that the families of infants and toddlers with developmental disabilities or delays have the support needed to achieve their full potential in the context of everyday relationships, activities, and places. Early Steps identifies infants potentially eligible under IDEA Part C; completes an assessment of each eligible child’s skills and abilities; creates an Individualized Family Support Plan (IFSP) based on the family’s concerns, priorities, resources, and desired outcomes; and coordinates the provision of early intervention services and supports with the family in a way that involves the family and caregivers as they communicate and interact with the child throughout the day. A service coordinator assists families in gaining access to a variety of services and

supports all dependent on the child's needs. Services include, but are not limited to, early intervention sessions, vision/hearing services, assistive technology, family training, and other developmental interventions.

Early Steps uses a team-based primary service provider (TBSP) approach with each family eligible under IDEA Part C. Each family is assigned a single individual (primary service provider) that focuses on keeping a cohesive, consistent team working on the child's goals. This primary service provider uses coaching strategies to help family members and caregivers develop the unique skills they need to support child development, therefore enabling family members to learn the skills necessary to help their child and be actively involved in the future development of the child. Additional team members may provide direct services or serve as consultants to ensure that family members and caregivers are fully supported in addressing all the child's functional needs.

Purpose, Goal and Mission of Early Steps

The purpose of Early Steps is to ensure that families and caregivers of infants and toddlers with disabilities have the opportunity to enhance the development of their children within their everyday routines, activities, and places. The overarching goal of the program is to increase opportunities for all infants and toddlers to be integrated into their families and communities, and to learn, play and interact with children without disabilities. Early Steps provides appropriate early intervention services and supports to meet the needs of each child and family residing in Florida who are eligible for IDEA, Part C, from birth to thirty-six months of age. Services and supports are provided in accordance with the IFSP, which is modified in response to the changing needs of the child and family. The provider is responsible for implementing and coordinating the provisions of the CMS Early Steps system through collaborative community partnerships and resources including the regional CMS Network. The mission of Early Steps is to establish a coordinated system of supports and services for enhancing the capacity of families and caregivers to support the development of children with special needs and ensure that children with special needs are integrated in their communities.

Challenges Early Steps Faces

In a time when many state-funded programs are facing budget cuts and other threats to revenue, Early Steps has collaborated with the FDDC to identify and effectively implement strategies for sustainability. The FDDC awarded a contract to the Ounce of Prevention Fund of Florida to develop a strategic plan for sustainability. This effort resulted in the identification of over 600 possible strategies that were reduced through a rigorous analytic process to 40 well-vetted strategies. The result is a deliberately designed plan for meeting the goal of Early Steps sustainability set forth by the FDDC and the Early Steps State Office. The immediate challenges to Early Steps and to implementing the strategic sustainability plan include:

1. Funding and budgetary challenges
2. Cost inefficiencies
3. Lack of knowledge and awareness of Early Steps by key audiences

Funding and Budgetary Challenges

The budgetary constraints that are a result of the weak economic climate are a sobering reality that surrounds Early Steps. During the recent economic downturn, Early Steps has leaned on funds from the

American Recovery and Reinvestment Act (ARRA) to compensate for a tightening state budget. While this plan of action has been a sufficient stopgap during the last two fiscal years, funding from ARRA will no longer be available for draw-down after June 2011. This funding is not likely to be replaced, forcing Early Steps to re-evaluate its existing spending patterns in some areas while seeking to “tighten the belt” in others.

Early Steps does limited, if any, systematic fund raising. This is partially due to policy constraints at the state level and local lead agency restrictions. There are strategies to increase fund-raising capacity outlined in this plan; however, there are no ‘quick fixes’ to increase revenue streams. A further challenge is that, in some cases, implementing these strategies will require that Early Steps spend money now in order to save money or increase revenue later. Early Steps will need to weigh the benefits and costs carefully and possibly find external sources to cover these costs.

Cost Inefficiencies

Inefficiencies embedded in the operating context of state and local offices are, in many cases, responses to policy and funding realities. For example, federal policy requires Early Steps to provide services to all children in need; however, the fixed and limited budget in no way keeps pace with the demand. Further, reimbursement for many of the services provided through the specific approach Early Steps is required by federal law to follow is not covered by insurance or Medicaid payments, and when these services are covered, it is at a lower reimbursement rate than clinic-based services. In many cases, service providers also struggle with providing services within the Early Steps structure because it is expected that services be provided in the natural environment to families spread over large geographic areas necessitating a large and growing travel expense, which must also come from a limited budget. Tracking services and managing cases have been accompanied by an ever-increasing array of documentation and regulatory requirements that require highly competent time management and often leave key line staff facing the dilemma of serving the family or doing the paperwork. While there have been creative responses at the local level to work around some of these issues, a coordinated and systematic effort at the state level is sorely needed.



While Early Steps has little or no control over some of these inefficiency issues, there are other types of cost efficiencies that Early Steps can more readily address regarding recruitment and retention, caseloads, documentation and other factors. A team effort for implementing the strategies in this plan that address inefficiencies in these areas will require effort, but with a high probability of success.

Lack of Knowledge and Awareness

Data collection found that Early Steps is not recognized as a separate agency of CMS, if recognized at all, by many key stakeholders. Throughout the research process, the term ‘functionally invisible’ has been used in dialogue. Further, Early Steps is consistently mistaken for Early Head Start and other organizations that work with the birth to three-year-old population but do not address developmental disability or delay. The misunderstanding, or non-understanding, by funding bodies, primary referral sources (e.g. pediatricians), community social service systems and families, is a weakness, as it is easier

to defund a program that you do not recognize or understand. It should be noted that the plan does reflect one strategy for developing a systemic response to public relations and communication issues that is in addition to the forty strategies that were developed from the data. ESSO has already begun the process of developing a public relations response and an interim analysis was forwarded to ESSO to begin the critical public relations and visibility effort prior to the completion of this plan.

Critical Success Factors

The collaboration between Early Steps and the FDDC to proactively address the issue of a sustainability plan is a key first step in achieving sustainability for Early Steps. Another factor for developing a strategic plan for sustainability was the identification of a stakeholder group that could provide diverse perspectives on the varied issues related to Early Steps' sustainability. The main component of a strategic plan for sustainability is a set of prioritized strategies with accompanying action steps generated from an evidence base that, when implemented, will improve the sustainability of the target organization. A strategic plan will usually address a set of critical factors via the combined strategies and action steps. The critical success factors crucial to this project include:

1. Solidifying existing revenue streams and finding additional revenue streams
2. Improving cost efficiency of program service provision
3. Increasing visibility of the program to divergent stakeholders
4. Improving program operations to increase recruitment and retention of quality providers

Revenue Streams

Revenue can be increased over time with concerted effort in improving reimbursement, seeking endowments and other legacy monies, improving fund raising, and other factors. These are, as noted, longer term, but still vital for the continued existence of Early Steps. The planning process produced multiple strategies targeting revenue, many of which are designated as critical. Early implementation of these strategies is expected during the implementation process.

Cost-Efficiency

Several strategies address cost efficiencies, but this is fortunately an additional versus a beginning effort. Representatives at ESSO have noted that LES have already begun the process of curtailing costs, which has resulted in some savings that can be used as a baseline for systematizing cost efficiencies statewide. Cutting costs, though painful, is frequently more feasible than finding new revenue streams. Early Steps showed foresight in beginning the cost-cutting process even before the strategic sustainability planning process began.

Visibility of the Program

As noted, there is an effort under way to improve public knowledge and awareness of Early Steps. Several strategies will support the shaping of messages to key stakeholder groups, increasing the impact of a systematic public relations and communication campaign. Being visible must be accompanied with being successful, so other strategies target improving service delivery, gathering data to prove effectiveness, and gaining state-level information on return on investment (ROI). Visibility must be understood as more than knowing Early Steps exists - it must have solid evidence for its success and that families will benefit if referred.

Recruitment and Retention

Effectiveness, revenue and cost efficiency all rely on having quality staff in the program. Programs become more effective when staff gain experience and learn to work optimally in the program framework. This requires longevity in employment. Several strategies address recruiting quality staff and others address how to make their tenure enjoyable and fulfilling.

Priority Listing of Strategies

This section provides a list of the 40 strategies that resulted from the data collection and analytic process. Strategies are divided by tiers to emphasize which strategies have the greatest potential to contain costs, provide additional revenue, or are important for providing information required by other strategies.

Placement in a tier was based on a mixed- methods analytic approach to objectively identify a hierarchy of strategies based on importance to sustainability. Five scales were derived that were weighted equally and combined to generate an overall rating that was then sorted from largest to smallest. Each scale was a six-point scale, with larger numbers meaning more of the attribute. Thus, the possible range was 5 to 30. The larger the number, the more important the strategy is for strategic sustainability.

The five scales are:

1. The amount and quality of narrative data that supports inclusion of the strategy in the final 40
2. The amount and quality of narrative data that supports how central the strategy is anticipated to be for improving cost efficiency, revenue generation or service provision
3. The relevance rating of each strategy calculated by averaging the scores from the 56 respondents to the relevance and feasibility survey
4. The feasibility rating of each strategy calculated by averaging the scores from the 56 respondents to the relevance and feasibility survey
5. The degree of linkage to other strategies; or in other words, how important the strategy is in support of, or being supported by, other strategies

The result of the analysis found natural separations between numbers that resulted in four groups, or tiers, of strategies that clustered from high to low in importance to sustainability. Strategies were re-ordered from what the stakeholder groups may remember from previous interim documents and discussion, this time based on analytic results. The final tally has Tier 1 with the seven most impactful strategies based on the analysis described above, plus the public relations strategy noted earlier. Tier 2 has ten strategies, Tier 3 has fifteen and Tier 4 has eight.

It is recommended that strategies be addressed by tier during implementation, with consideration being given to the resources available for each strategy within a tier. There was no additional attempt to order strategies within tiers, thus allowing the implementation group the freedom to develop implementation plans with the least amount of restriction while providing confidence that the most relevant strategies are being given priority. While implementation of strategies in one tier does not have to wait until all strategies are resolved in a previous tier, it is important to avoid spreading resources so thin across tiers that resolutions of strategies are delayed or abandoned, lowering

confidence and possibly resulting in termination of implementation. Further, some strategies in later tiers are dependent on information resulting from completion of strategies in earlier tiers, so it is suggested that these Tier 1 and Tier 2 strategies be started as soon as possible to avoid delaying resolution of other strategies.

Tier 1 Strategies

1. Develop a definitive definition of the Team Based Primary Service Provider (TBPSP) approach for Florida, clarify (since many LES had different interpretations of what ESSO was communicating), and strengthen state policy requiring the use of the TBPSP model for service delivery.
2. Provide support for local creative partnerships for resource development, e.g., fund-raising.
3. Increase level of reimbursement for Medicaid, Medicaid HMOs and Part C providers to better recruit and retain quality providers.
4. Reduce Service Coordinator caseloads.
5. Obtain evidence of effectiveness and return on investment (ROI) specific to Early Steps and its implementation of the TBPSP model.
6. Standardize, systematize and provide greater state- level support for travel, as this is a major cost as well as barrier for providing services in line with the TBPSP model.
7. Investigate the practices and processes of LES that are routinely coming in on or under budget so they can be shared statewide, then develop a plan for sharing and evaluating across the state.

The maximum caseload for a service coordinator to reasonably meet all documentation and quality requirements is 60-65 families. For almost all service coordinators, this is surpassed. As one service coordinator stated, "I just got to 86 after being here for 4 years, I had over 100 when I started. You cannot successfully manage a caseload that big."

Additional: Develop, complete, and evaluate a targeted public relations campaign to increase awareness of Early Steps among key stakeholder groups including the Florida Legislature and other policy/funding entities, referring entities and organizations (e.g. pediatricians), local and state level service provider organizations, communities and families.

Tier 2 Strategies

8. Develop and operationalize empirically- based procedures to ensure that only children in need of services continue to receive them.
9. Develop incentives and consequences for providers to correctly implement and support the TBPSP approach.
10. Work cooperatively with Medicaid, Medicaid HMOs and insurance organizations to provide coverage for services related to the TBPSP.
11. Develop and implement a needs-based sliding scale to charge parents for Early Steps services based on income.

12. Improve billing across all LES regions to ensure that the hierarchy of billing is in place and fully utilized so all available alternative payer sources are exhausted before Part C funds are used.
13. Improve the enrollment process for the CMS provider group (Early Steps), Medicaid, and the LES offices.
14. Improve provider training and mentorship procedures and opportunities to enhance provider and Service Coordinator understanding and acceptance of the TBPSP as well as improving service delivery.
15. Increase training and coaching for pediatricians and other key referral sources to improve understanding of, and comfort with, the TBPSP model, especially the referral process.
16. Reduce Service Coordinator paperwork.
17. Complete a cost analysis for employing versus contracting with providers and enact policies to support provider hiring/contracting practices based on evidence.

As one service coordinator noted, “We really appreciate our working relationship with pediatricians. They are great referring sources and some are very good at detecting [developmental] delays. I just wish they understood the program and the model we use. It’s really stressful when you have to tell a parent that what they were told by a pediatrician is not right. It’s stressful for everybody involved.”

Tier 3 Strategies

18. Strengthen and consistently implement policy for ESSO to support the LES decisions on service provision.
19. Improve timeframes for policy development and implementation to improve planning and projecting for possible consequences.
20. Establish minimal qualifications to be a parent organization for LES. Consider relocating any LES whose parent organization does not meet minimal qualifications.
21. Develop the steps for, and then implement, strategies to develop an insurance mandate for Florida.

As one LES noted, “We’ve been below capacity for service coordinators for a while. We can’t hire because our parent organization has a hiring freeze. I don’t understand this since we get our money from the state contract. This has put a lot of stress on the remaining service coordinators.”

22. Encourage enrollment in Medicaid for families that are eligible and, when mandatory health insurance begins, assist any family without insurance in finding insurance.
23. Overhaul/improve the education and experience qualifications for providing early intervention services.
24. Establish relationships with university training programs in the state to influence curriculum and provide practicum and internship opportunities with Early Steps and to train/educate students on the TBPSP approach.

25. Enact policies/procedures necessary to increase cohesive teaming with the expected benefit of increased trust and mutual respect.
26. Hire/support evaluation and consultation teams to complete evaluations and provide consultation services to LES providers.
27. Utilize evidence-based parent developmental training, such as the Hanen Approach, as a first service tier prior to direct services for non-medically complex children.
28. Evaluate the cost effectiveness and staffing required to have service coordinators operate in dual positions of service coordinator and provider for simpler cases needing less intense services.
29. Generate a list of empirically supported factors that interfere with a parent's ability to fully utilize the Early Steps program and develop/implement processes to improve parental capacity to engage in services.
30. Improve parental level of understanding of the mission and vision of the program to increase buy-in for the program and understanding of their role as an involved team member and partner.
31. Develop a process to identify families that are consistently uninvolved, missing appointments, or not benefiting due to limited engagement.
32. Systematically investigate technology needs and gaps that technology can fill to reduce costs; and develop a plan to acquire, learn and use the technology appropriately.

As service coordinators noted, "What is needed is communication so we can have input on what technology is needed. We need something that can work in houses with no electricity... we don't know how to use them or they don't work in the homes we go to."

Tier 4 Strategies

33. Restructure ESSO and LES to have appropriate levels of recommended administrative staff. Consider redirecting salaries to hire more service coordinators, family resource specialists and evaluators.
34. Fund a state level research position that will quickly and accurately respond to the needs of the LES for research, information to support local grant writing efforts, and other empirical support.
35. Work to ensure maximum draw- down of funds to support Early Steps, including current and additional funding.
36. Fund a state- level Medicaid, Medicaid HMO and Private Insurance expert that focuses on policy and best practices to maximize these revenue and reimbursement streams.
37. Ensure that IFSP teams have the skills, knowledge and abilities to meet the individual child and family needs.
38. Develop a resource site for LES to post questions and replies.
39. Develop a state-wide medical record and billing system to reduce paperwork and increase consistency of documentation while reducing redundancy. (May be resolved via a 3rd party administrator)

40. Work to systematically assess and improve the current data system, or investigate a new data system if funds can be found and the current system cannot be improved on. (May be resolved via 3rd party administrator).

Strategy Description and Action Steps

This section discusses each strategy in turn, provides the action steps needed to accomplish each strategy, and states the organization(s) responsible for carrying out the action steps. Implementation will require the ESSO and the LES to assign specific staff responsible for action steps. Additional refinement of action steps will likely be necessary, as resources and other factors may change over time. It is important to recognize that the action steps are preliminary and should be used as guidelines for further development. This is not to imply that the action steps lack credibility. On the contrary, the individuals developing the action steps were well grounded in the research that finalized the strategies and had varying perspectives necessary for the development of the overall plan. There were ESSO staff present during the generation of the action steps which further grounded the process. What is required to strengthen the action steps is greater participation and input from the local offices to ensure that action steps are responsive to individual differences, increasing the probability of successful implementation. Three members of the planning team that developed the action steps were also directors of local offices. This ensured representation of the LESs, but should not be considered as completely representative of the diversity present across all LES locations.

A review of action steps resulted in bulleted lists of action steps placed in a logical but not absolute order for implementation. Action steps are not numbered, as it is expected that the order may change when implementation reveals additional information that needs to be considered. It is also likely that some action steps will be executed simultaneously, or will resolve sooner, leaving others in progress until completed.

An implementation analysis was completed to find similar or identical action steps to ascertain whether it would be feasible to construct implementation recommendations based on common action steps instead of, or along with, a hierarchy of strategies as described in the previous section. The assumption is that the diversity of strategies should result in similar diversity in action steps. While some commonality between action steps was expected, a great many common action steps would suggest that the steps were created in a rote and not especially imaginative fashion, or that the group assembled to complete the steps was insufficiently versed in the contextual milieu in which the Early Steps organization is embedded. When doing a mixed analysis of several types of data, testing for violations of logical assumptions acts as one form of data validation and is critical to accuracy.

The results of the implementation analysis suggest that the individuals involved in the action step planning process were highly motivated, understood the context of Early Steps and developed action steps specific to each strategy. There was very limited crossover between action steps. As the action steps are viewed as the best fit for the strategies, the strategies themselves are considered the best fit for the data at hand. Additional strategies past the final 40 are viewed as redundant, while eliminating any of the final 40 strategies would result in incomplete coverage. Overall, this places considerable confidence in the relevance of the strategies and action steps to the issue of sustainability of Early Steps, and that they provide maximum coverage with minimum redundancy.

Tier 1 Strategies

Strategy 1: Develop a definitive definition of the Team Based Primary Service Provider (TBPSP) approach for Florida, clarify (since many LES had different interpretations of what ESSO was communicating), and strengthen state policy requiring the use of the TBPSP approach for service delivery.

Action Steps	Entity Responsible
<ul style="list-style-type: none"> All parties involved in implementation will need to be educated and reminded that the natural environment aspect of the TBPSP is the approach that fits the federal requirements and draws down the federal dollars for Part C. Anecdotally, there is evidence that the approach results in cost savings compared to clinic based services, but this has not been validated in Florida via a cost analysis. 	<p>ESSO/LES/External Research Partner</p>
<ul style="list-style-type: none"> The cost effectiveness of the TBPSP approach will be established via a cost analysis study which will provide additional information for the TBPSP (see Strategy 5). 	<p>ESSO/External Research Partner</p>
<ul style="list-style-type: none"> The implementation team will review the policy and guidance documents of the TBPSP approach in order to see if revisions are needed. Additional training tools beyond these documents will be developed. 	<p>ESSO/External Research Partner</p>
<ul style="list-style-type: none"> Provide education and training for LES and service providers on what the TBPSP approach is; flow of training should include an introductory learning unit, facilitated self- assessment, then learning units that are followed by a specific coaching component. <ul style="list-style-type: none"> Require teams to be trained together Look at the strengths/challenges within each LES Do a self- assessment with each LES using an outside facilitator Develop indicators based on the results of the self- assessment 	<p>NECTAC/ESSO training unit/SERRC/External Research Partner</p>
<ul style="list-style-type: none"> ESSO policy on TBPSP approach needs to be given to local providers, parents, physicians (i.e. stakeholders) in the form of a public relations campaign to ensure that everyone is implementing the TBPSP approach with fidelity (see additional strategy at the end of Tier 1 below) <ul style="list-style-type: none"> Ensure that the material on the team-based approach emphasizes that the team is responsible for establishing needed services via the IFSP, which in turn may result in one provider, e.g. a speech therapist, for services 	<p>ESSO/FICCIT/External Research Partner</p>

Strategy 2: Provide support for local creative partnerships for resource development, e.g., fund-raising.

Action Steps	Entity Responsible
<ul style="list-style-type: none"> Investigate and plan resource development options to be as cost neutral as possible. It will be important to limit costs for resource development, while still meeting strategy goals, to maintain overall congruence with the cost- savings goal of this plan. 	<p>ESSO/LES</p>
<ul style="list-style-type: none"> Define current restrictions on resource development efforts as well as the internal expertise (re: fund-raising/development and communications) by LES based on the agency/entity in which they are housed. Obtain and disseminate information on which LES can and do conduct community outreach activities, what is the role of public awareness in their communications strategies, and who their current corporate and community partners are. 	<p>External Research Partner/ESSO/LES</p>
<ul style="list-style-type: none"> Explore establishment of a Direct Service Organization (DSO) in legislation to serve as a statewide vehicle for the Florida Consortium or other entity to conduct strategic communications and resource development outreach. 	<p>Partnership Counsel</p>
<ul style="list-style-type: none"> Explore mechanisms for establishing an Early Steps Scholarship/Education Trust to attract private donations and perhaps utilize the corporate tax credit model similar to those created for private school tuition support 	<p>Partnership Counsel</p>
<ul style="list-style-type: none"> Explore cause-related marketing opportunities to align Early Steps program services with commercial entities, child-related industries, and celebrities who are or can be identified with child development promotion. Examples include the sports/athletics, athletic training/fitness, nutritional and child products industries. 	<p>Public Relations & Advertising Ally/Project of a business school for upper level students</p>
<ul style="list-style-type: none"> Create an Early Steps Fellowship program through the State University System that focuses on a diversity of disciplines (e.g., medicine, social work, therapeutic sciences). Developing Early Steps Fellowships will allow promising under-grad and graduate students to work cooperatively with LES and providers and to develop special projects which will offer opportunities for testing new mechanisms and ideas in Early Steps. 	<p>ESSO/LES/Florida Campus Compact/Higher Education Leadership</p>
<ul style="list-style-type: none"> Develop and implement innovative outreach processes that will improve cooperation, communication and mutual growth to ensure consistent access to quality, newly-trained providers. Also, examine the option of Endowed 	<p>ESSO/LES/Florida Campus Compact/Higher Education Leadership</p>

Chairs in Early Intervention for assisting specialized faculty with their research and teaching.	
<ul style="list-style-type: none"> Survey LES for their capacity in identifying family members of Early Steps-served children for their interest in being more active in communications, financial support, or other volunteer activities in support of Early Steps program services. If there are parents/grandparents and family members who express interest, a plan of action to engage them should be piloted in three to four locations. 	ESSO/LES/External Research Partner
<ul style="list-style-type: none"> Develop a framework for an Early Steps Alumni Association to promote the success stories of children/youth and family members to leverage their authentic voices for the value of the services and the importance of community involvement in support activities. 	LES Directors/External Research Partner
<ul style="list-style-type: none"> Develop and implement an outreach plan to engage the Florida Association of Children’s Hospitals in developing coordinated communications and community outreach activities for the Early Steps Program. Develop similar outreach plans to engage the Florida Pediatric Society, OB/Gyn network, Florida Occupational Therapist Association and other like-minded allied organizations. 	ESSO/LES/Ally Associations
<ul style="list-style-type: none"> Develop connections with like-minded statewide and community-based organizations to share knowledge and resources via cooperative agreements (e.g., literacy/libraries, extension services/parenting and child development resources, nutritional/obesity prevention). 	ESSO/External Research Partner

Strategy 3: Increase level of reimbursement for Medicaid, Medicaid HMOs and Part C providers to better recruit and retain quality providers.

Action Steps	Entity Responsible
<ul style="list-style-type: none"> Conduct a cost study of rates and use the results to communicate the need for a rate increase for therapists providing EI services at the same rate as currently in the Therapy Handbook. 	ESSO/LES/Research Partner
<ul style="list-style-type: none"> Explore use of a follow- up evaluation for program exit that will target relevant outcomes and processes. 	ESSO/LES
<ul style="list-style-type: none"> Increase allowable cost reimbursement of EI Group sessions from one hour to two hours. Many providers have stated interest in providing group sessions, but not at the current one-hour limit. 	ESSO/LES/Research Partner

<ul style="list-style-type: none"> Propose an interpretation response to the medical necessity definition be included in the Medicaid Early Intervention handbook currently under revision. 	ESSO/Research Partner
<ul style="list-style-type: none"> ESSO will develop and implement a plan to work with AHCA to develop a process to investigate Medicaid denials that appear to not follow Medicaid rules and disseminate to LES for their education and use. 	ESSO/AHCA/LES/State Medicaid representative
<ul style="list-style-type: none"> Work with AHCA to have the IFSP considered as the sole authorizing document for Part C children with Medicaid. Improve the current process of getting physician approval, which is frequently a barrier to getting services started within 30 days. <ul style="list-style-type: none"> Investigate whether other states have the IFSP as the sole authorizing document and incorporate their process if feasible. 	ESSO/AHCA/CMS
<ul style="list-style-type: none"> Develop a plan to have provider-to-provider consultations and IFSP development, meetings and updates paid for by Medicaid. 	ESSO/LES/State Medicaid representative/CMS

Strategy 4: Reduce Service Coordinator caseloads.

Action Steps	Entity Responsible
<ul style="list-style-type: none"> Assess reasons for high caseloads across LES and develop responses so they are suitable to the needs of each LES. 	LES/ESSO
<ul style="list-style-type: none"> Develop empirically- based responses or models in the form of pilot programs. 	LES/ESSO/Research Partner
<ul style="list-style-type: none"> Implement pilot programs across the state to determine if using a blended (some dedicated and some dual- role service coordinators) service coordination system would reduce caseloads. Vary options in service coordinator models in the pilot projects per the models developed in the previous step. 	LES/ESSO/Research Partner
<ul style="list-style-type: none"> Evaluate the success of each model and decide whether one or multiple models will be used based on differing contextual and implementation issues specific to sites, ensuring that TBSP core components are not violated. 	LES/ESSO/Research Partner
<ul style="list-style-type: none"> Consider establishing a career ladder with different responsibilities for different levels. Share current practices throughout the state. 	ESSO /LES
<ul style="list-style-type: none"> Look at opportunities for alignment with other partners in the community (Head Start/Healthy Families) to reduce caseloads through empirically supported referrals to 	LES/ESSO/Partnering Agencies

developmental parenting or other programs.

- Implement dismissal criteria during periodic reviews (6 months, 1 year) in order to dismiss children who no longer need services and ensure children are getting the right services to make optimum progress.

ESSO/LES

- Linkage: Strategies 8, 16 and 28

Strategy 5: Obtain evidence of effectiveness and return on investment specific to Early Steps and its implementation of the TBPSP approach.

Action Steps	Entity Responsible
<ul style="list-style-type: none"> • Complete a cost- effectiveness analysis comparing the TBPSP to clinic-based services as the first step in completing a cost-benefit return on investment (ROI) study. A cost analysis is the beginning of the ROI research process. 	ESSO/LES/External Research Partner
<ul style="list-style-type: none"> • Conduct retrospective study of Florida Early Steps effectiveness including, but not limited to, the TBPSP approach. <ul style="list-style-type: none"> ○ Cooperatively develop reasonable outcomes with ESSO and LES partners ○ Report individual results for each LES as well as aggregated across LESs 	ESSO/LES/External Research Partner
<ul style="list-style-type: none"> • Conduct a prospective- effectiveness study of the TBPSP once uniformity and fidelity are increased across LES <ul style="list-style-type: none"> ○ Report individual results for each LES as well as aggregated across LESs. 	ESSO/LES/External Research Partner
<ul style="list-style-type: none"> • Complete an intensive cost-benefit study utilizing the cost effectiveness, retrospective and prospective studies, that includes tangible, intangible and other costs/benefits, arriving at an empirically- based ROI number that can be used for funding, grant writing, and other needs. <ul style="list-style-type: none"> ○ Individualize results to LES as well as aggregated 	ESSO/LES/External Research Partner
<ul style="list-style-type: none"> • Linkage: Strategies 1, 2, 3, 6, 7, 9, 17, 18, 21, 23, 24, and 40 	

Strategy 6: Standardize, systematize and provide greater state- level support for travel, as this is a major cost as well as barrier for providing services in line with the TBPSP approach.

Action Steps	Entity Responsible
<ul style="list-style-type: none"> • Develop a protocol for monitoring travel and service delivery. Consider convening a new workgroup to develop and test the protocol. 	ESSO/TBA workgroup
<ul style="list-style-type: none"> • Share current travel reimbursement practices across LES. 	ESSO/LES

<ul style="list-style-type: none"> Develop options and categorize in order to test various travel reimbursement methods. <ul style="list-style-type: none"> Consider piloting a flat rate for travel for each visit in certain LES. (include rural and urban LES sites) 	ESSO/LES
<ul style="list-style-type: none"> Develop a mechanism for capturing data related to no-shows. Look at no-show data and analyze cost to the system/provider. <ul style="list-style-type: none"> Link with fee based on a sliding scale 	ESSO/LES
<ul style="list-style-type: none"> Develop best practices and options for using technology to do consulting for hard-to-reach families. Once developed, formalize and disseminate, with training as needed, to ensure that practices are as uniform as possible across the state. 	ESSO/LES/NECTAC
<ul style="list-style-type: none"> Linkage: Strategy 16 	

Strategy 7: Investigate the practices and processes of LES that are routinely coming in on or under budget so they can be shared statewide, then develop a plan for sharing and evaluating across the state.

Action Steps	Entity Responsible
<ul style="list-style-type: none"> Collect cost-containment management practices for each LES. <ul style="list-style-type: none"> Provide examples, include use of technology, time needed to use tools developed at sites, etc. 	LES/ESSO/External Research Partner
<ul style="list-style-type: none"> Analyze information and categorize. 	ESSO/External Research Partner
<ul style="list-style-type: none"> Drill down with each LES to determine who is staying within budget. 	ESSO/LES
<ul style="list-style-type: none"> Develop a plan for sharing strategies across the state. 	ESSO
<ul style="list-style-type: none"> Incorporate effective strategies within contractual requirements. 	ESSO/LES/Hosting Agencies

Additional Strategy: Develop, complete, and evaluate a targeted public relations campaign to increase awareness of Early Steps among key stakeholder groups including the Florida Legislature and other policy/funding entities, referring entities and organizations (e.g. pediatricians), local and state-level service provider organizations, communities and families.

Action Steps	Entity Responsible
<ul style="list-style-type: none"> Develop and complete a public relations plan targeting key stakeholders, e.g. material development, testing, dissemination, and evaluation as some possible sections. 	ESSO/External Research Partner
<ul style="list-style-type: none"> Develop public relations materials, e.g., brochures, 	ESSO/External Research

posters, public service announcements, targeting specific key stakeholder groups.	Partner
<ul style="list-style-type: none"> When available, update public relations material based on effectiveness and ROI results and include in materials targeted to funders, providers, referring sources and parents. Ensure that the evidence of the effectiveness of the TBSP approach for birth to three children is available to counteract perceptions that the approach was selected to cut services and save money or that clinic-based services are automatically more effective. 	ESSO/LES/External Research Partner
<ul style="list-style-type: none"> Test the material using appropriate methods, e.g. product-oriented focus groups, analyzing results, and updating material based on results. 	ESSO/LES/External Research Partner
<ul style="list-style-type: none"> Systematically disseminate materials (from the dissemination component of the public relations plan) to key stakeholders. 	ESSO/LES/External Research Partner
<ul style="list-style-type: none"> As part of the public relations component, review statutes related to early intervention to ensure that Part C is specifically represented in legislation. If not present, then work to create Part C- specific legislation. <ul style="list-style-type: none"> Ensure legislative support for due process rules in legislation. 	ESSO/LES/External Research Partner
<ul style="list-style-type: none"> Evaluate the impact of each component of the public relations campaign using rigorous evaluation methods to ensure that resources are appropriately targeted and stakeholder groups have increased awareness and understanding of Early Steps. 	ESSO/LES/External Research Partner

Tier 2 Strategies

Strategy 8: Develop and operationalize empirically- based procedures to ensure that only children in need of services continue to receive them.

Action Steps	Entity Responsible
<ul style="list-style-type: none"> Add/change exit code in data system: Age- appropriate skills. 	ESSO/Data User workgroup
<ul style="list-style-type: none"> Review the work and recommendations of the Eligibility Workgroup currently reviewing/altering eligibility information and incorporate as needed. 	ESSO/Eligibility workgroup
<ul style="list-style-type: none"> Look at other state’s policies to see how they are addressing “dismissal criteria.” Develop these or similar criteria for Early Steps. 	DAC/NECTAC/ESSO

<ul style="list-style-type: none"> Strengthen policy related to transitioning children out of Early Steps prior to age three. Provide training related to models for decreasing services gradually prior to transitioning the child out of the program. 	ESSO/LES
<ul style="list-style-type: none"> Review data to determine frequency of children leaving program prior to age three, statewide and within LES. Review child outcome data for further information. <ul style="list-style-type: none"> Develop best practice criteria for LES that are dismissing children appropriately and with greater frequency, then share with other LES. Track implementation for impact. 	ESSO/LES/Continuous Improvement workgroup/Child Outcome Leadership Team
<ul style="list-style-type: none"> Require ongoing assessment to determine if services should be decreased on a regular basis by IFSP team. Provide training if needed and develop a tracking system to ensure that assessments are being completed in a timely and accurate manner. 	ESSO

Strategy 9: Develop incentives and consequences for providers to correctly implement and support the TBPSP approach.

Action Steps	Entity Responsible
<ul style="list-style-type: none"> Develop CEU opportunities for current providers to increase their desire to remain as Early Steps providers. 	ESSO/LES recruiters
<ul style="list-style-type: none"> Develop and provide needed training on appropriate documentation that meets medical and developmental requirements. Training should qualify for CEUs and be made available in person, online or through conference calls. Providers also need enrollment packets (hard copy and online) that include “how to” on Medicaid billing with key terms to use, access to most updated forms, and reminders when forms have changed. 	ESSO/LES recruiters
<ul style="list-style-type: none"> Look for corporate partnerships to support an incentive program to provide compliant providers with additional resources they want and need: therapy tools/products, conference registration/scholarships, gas cards, etc. 	AHCA/ESSO/LES
<ul style="list-style-type: none"> Work cooperatively with AHCA to develop higher reimbursement rate from Medicaid, Medicaid HMOs and private insurances (raising Part C rates should be carefully assessed to avoid being counterproductive) to accommodate for providing services in the natural environment. 	AHCA/CMS
<ul style="list-style-type: none"> Identify key provider performance measures, clearly define them, provide examples for each measure, disseminate 	ESSO/LES

them to providers, and track performance, putting low performers on corrective action and removing them if issues are not addressed.

- Linkage: Strategies 1, 3, 13, 14, 27 and 26

Strategy 10: Work cooperatively with Medicaid, Medicaid HMOs and insurance organizations to provide coverage for services related to the PSP approach.

Action Steps	Entity Responsible
<ul style="list-style-type: none"> • Through research, define and determine the issues relating to refusal for coverage of TBSP services by Medicaid HMOs and private insurance providers. Likewise, determine what the appeals/complaint process is and seek counsel as per legal alternatives when coverage is denied. Collect prevalence information on denials of coverage, and research how other states handle this process. 	Research Partner/LES/ESSO
<ul style="list-style-type: none"> • Analyze the impact of the Federal Health Care legislation on Early Steps families and participants. If the October 1, 2010, implementation addresses children’s coverage and pre-existing conditions, what do we know and what steps need to be taken to determine how many Early Steps participants are affected and what can be accomplished in the short term to expand access to coverage? If the new congress follows through on reversing or changing the legislation, develop plans to adapt to said changes as needed. 	AHCA/ESSO/Research Partner
<ul style="list-style-type: none"> • Assess the relationship between AHCA and Medicaid HMOs in drawing contracts that affect Early Steps client families. What services are covered, to what extent, and how are important dimensions such as transportation for services handled? Is AHCA enforcing all of the federal Medicaid requirements, and through what mechanism are concerns with HMO services being expressed? Is there a clear grievance mechanism through easily accessed on-line or via the telephone? 	ESSO/AHCA/Family Partners
<ul style="list-style-type: none"> • HMO executives should be educated on the cost benefit of the TBSP approach so that up-front parent/child focused-services can be shown to avoid later costs in more extensive and expensive therapies. Outreach to the Managed Care Association, the lobbying arm of the HMO network, should focus on the statewide impact and benefit of preventive/early intervention care and services. Presentations should be both factual and in language 	External Research Partner/Family Advocates

which is easy to digest in business terms.

- Use the opportunities presented by the coming transition of state leadership (Governor, Cabinet members and lawmakers) to educate them on the importance of early intervention services as both cost-beneficial and necessary for positive outcomes to a significant population of children. A unified voice among parents, providers, community leaders and state agency allies can assist transition planners in placing Early Steps' services on the their agenda for policy and budgetary priority. Family Partners/FDDC/ESSO
- Linkage: Strategies 19 and 31

Strategy 11: Develop and implement a needs-based sliding scale to charge parents for Early Steps services based on their income.

Action Steps	Entity Responsible
<ul style="list-style-type: none"> • Complete research and development of a Florida Early Steps needs-based sliding scale. It has been noted by ESSO that this work has already begun and that progress is being made. The implementation team should request a progress update from responsible ESSO staff. 	ESSO
<ul style="list-style-type: none"> • Implement sliding scale through the third party administrator (TPA) within 12 months. 	ESSO/LES/TPA

Strategy 12: Improve billing across all LES regions to ensure that the hierarchy of billing is in place and fully utilized so all available alternative payer sources are exhausted before Part C funds are used.

Action Steps	Entity Responsible
<ul style="list-style-type: none"> • Set up a system to provide targeted training on the appropriate hierarchy of billing and procedures for denials and other potential events. Potential steps include: <ul style="list-style-type: none"> ○ Develop procedural manual ○ Identify appropriate contacts ○ Conduct pre-implementation research to assess pre-training level of compliance with hierarchy <ul style="list-style-type: none"> ▪ If a cost analysis indicates feasibility, each LES will be required to have a dedicated Third Party Maximization Specialist and collect data on the cost of this position compared to the revenue generated. Start with base- line data before the position is in place. Intent is for this position to pay for itself. ○ Implement training <ul style="list-style-type: none"> ▪ Provide training on insurance denials 	ESSO/LES/Training Unit

<ul style="list-style-type: none"> ▪ Provide EOB training ○ Ensure all LESs have the intervention data in the ES Data System for all payers ○ Track for fidelity of implementation ○ Post implementation evaluation to assess improvement ○ Address billing of evaluations and obtaining approval from parents to bill private insurance when available. 	
<ul style="list-style-type: none"> • Identify LES most successful in collecting third- party revenues based on third- party report and assess for and document best practices. <ul style="list-style-type: none"> ○ Develop a manual for easy reference. 	LES/ESSO/TPA
<ul style="list-style-type: none"> • Require productivity standards for service coordinators for maximization of TCM revenue. Find out which LES have these and are most successful, develop into best practices, consolidate in a manual and disseminate to all LES sites. 	ESSO/LES

Strategy 13: Improve the enrollment process for the CMS provider group (Early Steps), Medicaid and the LES.

Action Steps	Entity Responsible
<ul style="list-style-type: none"> • Research and identify LES with best application/enrollment processes, develop into best practices, consolidate in a manual and disseminate to all LES sites. 	ESSO/AHCA/CMS
<ul style="list-style-type: none"> • Look at each step of the application process including required forms for each of the three entities involved; develop a streamlined process that reduces duplication and meets all current requirements. <ul style="list-style-type: none"> ○ Note: many current problems stem from issues with HP (the third party fiscal agent). LES/CMS provider enrollment must monitor application/enrollment issues and report issues to ESSO/AHCA so they are presented on the concerns list for resolution. 	ESSO/AHCA/CMS
<ul style="list-style-type: none"> • Identify an enrollment coordinator for each entity and develop communication protocols so each applicant is kept informed throughout the process. <ul style="list-style-type: none"> ○ ESSO enrollment coordinator is believed to currently have too many other responsibilities. The other responsibilities should be reduced or eliminated to increase time on the enrollment task group. 	ESSO/AHCA/CMS
<ul style="list-style-type: none"> • Authorize LES provider recruiters to assist in application and recertification process. 	LES
<ul style="list-style-type: none"> • Mandate all entities to use Live Scan for fingerprint checks 	AHCA/CMS

early in the process so time is not wasted on ineligible applicants.	
<ul style="list-style-type: none"> • Provide an integrated system for online application processing to reduce use of outdated forms and overall turnaround time. 	CMS provider management units
<ul style="list-style-type: none"> • Create an application tracking system and run monthly data reports that show all applications currently in progress and the status of each. Identify 30-60-90-120 day goals and note areas where backlogs occurs so new strategies can be developed. 	CMS
<ul style="list-style-type: none"> • Use social networks (i.e. Facebook) to promote the program and recruit providers. 	ESSO/LES
<ul style="list-style-type: none"> • Offer regional quarterly workshops for potential and new providers to cover the TBPSP approach, common paperwork and billing issues, etc. 	LES provider recruiters

Strategy 14: Improve provider training and mentorship procedures and opportunities to enhance provider and service coordinator understanding and acceptance of the TBPSP as well as improving service delivery.

Action Steps	Entity Responsible
<ul style="list-style-type: none"> • Mentorship protocol should be standardized according to best practices and every LES should be required to implement a mentoring program, with empirically- based flexibility for what will work locally, with documentation of mentoring activities to develop into best practices and consolidate in a manual to disseminate to all LES sites. <ul style="list-style-type: none"> ○ Modifications currently proposed by Service Implementation workgroup and Florida Interagency Coordinating Council for Infants and Toddlers to address improving relevancy, structure and use of mentorships should be assessed for acceptance. Relevant modifications should be accepted and implemented. 	ESSO/LES
<ul style="list-style-type: none"> • Videos on the TBPSP approach should be developed in multiple formats for use with parents, providers, service coordinators, and others. Content should be specific and relevant to the different audiences. <ul style="list-style-type: none"> ○ Material should be systematically tested for desired outcomes and then implemented statewide. 	ESSO/Marketing and Advertising Firm

<ul style="list-style-type: none"> • Service coordinator paperwork and caseloads should be reduced to allow more time for training and mentorship with an expected beneficial effect on program effectiveness as well as retention of quality service coordinators. 	ESSO/LES
<ul style="list-style-type: none"> • Complete a cost assessment for a mentoring component, e.g. dedicated staff, part-time staff, volunteer cost avoidance, material, etc., to assist with implementation. 	ESSO/LES
<ul style="list-style-type: none"> • Linkage: Strategies 4 and 16 	

Strategy 15: Increase training and coaching on the TBSP approach to improve the understanding and comfort of pediatricians and other key referral sources (family practice, PAs, ARNPs and MSWs), especially regarding the referral process.

Action Steps	Entity Responsible
<ul style="list-style-type: none"> • Develop standardized presentation materials for use at pediatric and family- practice state conferences and local board meetings. <ul style="list-style-type: none"> ○ NOTE: tabletop displays are currently being shipped to every LES. Early Steps brochures were also already created, but too few were printed. It is unknown if they were vetted through a market testing process; if they have not, then they should be. 	ESSO/LES/CMS
<ul style="list-style-type: none"> • Use paid online advertising about program on Web sites that pediatricians already routinely access for diagnosis and billing codes. 	RFP through DOH marketing office
<ul style="list-style-type: none"> • Develop CEU-eligible training on TBSP approach and child development for pediatricians, family practice, PAs and ARNPs. 	ESSO training unit/Early Steps medical directors
<ul style="list-style-type: none"> • Educate office manager at large pediatric practices, starting with CMS medical homes. 	LES recruiters/CMS medical home staff
<ul style="list-style-type: none"> • Draft articles for AHCA quarterly bulletin, Florida Academy of Pediatrics, FMA magazine, etc. 	ESSO
<ul style="list-style-type: none"> • Develop and give medical providers a pre-printed referral or prescription pad for use in referring patients/parents to Early Steps so they will not write prescriptions that do not work within the TBSP approach. 	ESSO/LES

Strategy 16: Reduce Service Coordinator paperwork.

Action Steps	Entity Responsible
<ul style="list-style-type: none"> Do a time study to determine what types of paper work service coordinators are doing and if hiring more clerical staff or reducing redundancy or non-essential paperwork (described as paperwork that is not essential for the benefit of the client or to meet policy/regulatory requirements) could help. Sort by what kind of work and for whom they are doing the work, e.g. local or state. 	LES/ESSO/Research Partner
<ul style="list-style-type: none"> Identify and develop into best practices, consolidate in a manual and disseminate to all LES sites. 	ESSO/LES
<ul style="list-style-type: none"> Collaborate with CMS and Medicaid to see what paperwork is being duplicated and develop policies/forms that can be shared. 	ESSO/CMS
<ul style="list-style-type: none"> Train and use technology/data systems to work smarter, (i.e. word predictor software or voice activated dictation). 	ESSO/NECTAC/SERRC/Larry Edelman/MaryBeth Bruder
<ul style="list-style-type: none"> Streamline and address formatting issues of electronic IFSPs. Enhance data systems to enhance and track timelines. 	ESSO
<ul style="list-style-type: none"> Consider moving paperwork to a secure Web-based system that allows for auto-filling of information fields to avoid having duplication. 	ESSO/DOH/UF data system/LES

Strategy 17: Complete a cost analysis for employing versus contracting with providers and enact policies to support provider hiring/contracting practices based on evidence.

Action Steps	Entity Responsible
<ul style="list-style-type: none"> Do a qualitative and quantitative cost analysis on using contracted versus in-house employed providers to implement the TBSP approach. Consider selected programs that rated high and low on the self-assessment completed for strategy 4 for an outlier comparison design for the research. 	LES/ESSO/External Research Partner
<ul style="list-style-type: none"> Delineate best practices for developing and implementing in-house providers. 	LES/ESSO/External Research Partner
<ul style="list-style-type: none"> Implement in pilot sites and collect data on effectiveness. 	LES/ESSO/External Research Partner
<ul style="list-style-type: none"> Complete analysis and use results to further in-house provider choices as needed. 	LES/ESSO/External Research Partner
<ul style="list-style-type: none"> Consider the feasibility of contracting with one agency to 	LES/ESSO/External Research Partner

oversee the entire program for HR, IS, medical records.

- Linkage: Strategy 1
-

Tier 3 Strategies

Strategy 18: Strengthen and consistently implement policy for ESSO to support the LES decisions on service provision.

Action Steps	Entity Responsible
<ul style="list-style-type: none">• Improve understanding and consistency of implementation of the TBPSP approach.	ESSO, LES, external implementation team
<ul style="list-style-type: none">• Initiate a way for the LES staff to get to know, and have consistent communication with, their ESSO program manager (technical assistance advisor). Encourage program manager to consult with other ESSO team members.<ul style="list-style-type: none">○ When policies are given from the state office, provide options and brainstorm with the program manager and relevant LES staff. Increase systematic outreach to LES to better understand the potential consequences and contextual barriers to implementing new policies. Avoiding misunderstandings in policy statements will result in greater teamwork in generating and implementing policies.	LES/ESSO
<ul style="list-style-type: none">• Establish a consistent protocol for responding to policy questions from LES and a way to post questions so all LES can benefit from the interaction.	ESSO/Early Steps Bureau Chief
<ul style="list-style-type: none">• Linkage: Strategies 1, 18, and 24	

Strategy 19: Improve timeframes for policy development and implementation to improve planning and projecting for possible consequences.

Action Steps	Entity Responsible
<ul style="list-style-type: none">• Macro Level<ul style="list-style-type: none">○ Access key individuals involved with the transition of the Governor's office, share perspectives on the big picture systemic challenges, the value of the services being offered by Early Steps and the importance of inter-agency coordination to assure as seamless a transition as possible.○ Clarify the jurisdiction of each relevant state agency (e.g. DOH, AHCA, APD and DOE) as per their policy, regulatory, budgetary and program responsibilities as	ESSO/LES Directors/ Consortium/Governor's Office Transition Team Members

they affect early intervention services at the statewide and community levels.

- Clearly define the federal, state, and local processes for policy development as per rules, regulatory structures, communications channels, and all other dimensions of how programs are governed. All program directors, staff, providers, parents and allied entities need a clear and well- documented understanding of governance and lines of communication to ensure timely input and access to operational guidance.

- ESSO/LES Level

ESSO/LES Directors

- Anticipate policy issues with sufficient time to communicate possible changes, draft policies, locate required resources, re-direct essential personnel, and take other pragmatic steps between ESSO and LES.
- Develop a coordination specialist or make coordination of policy development and enactment part of current personnel duties to maximize the time between policy need detection, development, comments, roll out, evaluation, and any other steps needed to establish and enact policy.
- Establish and publish a timeline of changes in program regulations so that program directors are clearly aware of their responsibilities in aligning resources and working with providers and parents to coordinate all dimensions of service provision.

Strategy 20: Establish minimal qualifications to be a parent organization for LES. Consider relocating any LES whose parent organization does not meet minimal qualifications.

Action Steps

Entity Responsible

- Parent organizations need to provide support for the normal operating processes of LES and should be held accountable to, and only contracted with, if they willing and able to, do so. The following is not a comprehensive set of requirements, but merely represents the main points and areas of concern raised during the research process:
 - All LES contracts should require a minimum staffing pattern that must be maintained regardless of lead organization hiring freezes.
 - Contracts should specify that leads must not disallow travel and purchasing necessary for service provision according to the program model.

ESSO/LES

- To reduce paperwork, all leads should be required to support and use a statewide Early Steps data system.
- All leads should agree to a set percentage of allowable administrative costs.
- All field staff employed by LES should be provided with basic cell phone service, or reimbursed for business use of personal cell phones.
- Policies regarding travel, working from home or satellite offices should be flexible considering that implementation of this program requires travel and existing policies may not be logical when applied to Early Steps.
- LES lead contracts should require compliance with Early Steps policies, for example, one service coordinator position for every 65 children served.
- Set minimum qualifications for LES directors and minimum standards for lead agency fiscal management practices; request leads to consider/pursue opportunities to apply for grants and other funding to support LES.
- Contracts for LES should be reviewed for compliance annually.

Strategy 21: Develop and implement strategies to establish an insurance mandate for Florida.

Action Steps	Entity Responsible
<ul style="list-style-type: none"> ● Learn through research the How, Who, Why, and When of the activities through which other states established an insurance mandate for early intervention services. Reach out to the Office of Insurance Regulation (CFO office) for assistance in determining what statutory barriers to a coverage plan may exist in Florida. Analyze the impact of Federal Health Care legislation on this matter of mandated coverage. 	<p>External Research Partner/Office of the Insurance Commissioner</p>
<ul style="list-style-type: none"> ● Establish a strong research base for return on investment (ROI) for early intervention. Include the cost per child in Florida vs. other states, a determination of differences between current service models and ideal services (e.g. case load and depth/extent of service access). 	<p>External Research Partner</p>
<ul style="list-style-type: none"> ● With ROI research in hand, attract the support of business-sector allies to work cooperatively with insurance interests. For example, the corporate clients of a major insurer (e.g., Publix and Blue Cross/Blue Shield) can launch a pilot effort to cover Early Steps services for families. This 	<p>ESSO/Corporate Ally/External Communication Partner</p>

pilot can be utilized as a communications vehicle that highlights cost-benefit as well as measures of family improvement .

- After analysis of pilot data, use the results to further the development and implementation of steps needed to generate support for, and passage of, an insurance mandate for Florida’s children who are developmentally delayed. ESSO/Corporate Ally/External Communication Partner

Strategy 22: Encourage enrollment in Medicaid for families that are eligible and, when mandatory health insurance begins, assist any family without insurance in finding insurance.

Action Steps	Entity Responsible
<ul style="list-style-type: none"> • Investigate current protocols for enrolling income- eligible children across LES, identify promising practices, and establish a protocol across all LES. 	ESSO/LES
<ul style="list-style-type: none"> • All children who are income eligible for CMS should be referred to CMS as part of the service coordinator protocol. 	ESSO/Service Coordinator workgroup
<ul style="list-style-type: none"> • Explore feasibility of joint referral process between Early Steps and CMS for all children applying for Early Steps. 	ESSO/CMS

Strategy 23: Improve the education and experience qualifications for providing Early Intervention services.

Action Steps	Entity Responsible
<ul style="list-style-type: none"> • Certified teachers for appropriate age range (early education) are already accepted. Work to educate field about recruiting from this pool. 	ESSO
<ul style="list-style-type: none"> • Develop standardized review protocol for determining “degree equivalency” as currently this transcript review is too subjective. 	ESSO
<ul style="list-style-type: none"> • Grandfather in existing staff . 	ESSO
<ul style="list-style-type: none"> • The Personnel Improvement Center (PIC) grant is currently investigating improvements to effective hiring practices, causes of attrition, capacity for prep program partnerships to address local personnel needs, and increasing LES capacity to recruit, hire, develop, and support existing personnel. Use this information to develop more consistent education and experience qualifications. <ul style="list-style-type: none"> ○ Track effectiveness of the PIC grant for improving hiring practices and other points relevant to the grant 	ESSO

and assess for impact on the sustainability strategy.

Strategy 24: Establish relationships with university training programs in the state to influence curriculum and provide practicum and internship opportunities with Early Steps and to train/inform for the TBPSP approach.

Action Steps	Entity Responsible
<ul style="list-style-type: none"> Develop contacts to plan/implement internships in, if reasonable, all LES locations. 	ESSO/LES
<ul style="list-style-type: none"> Complete a cost analysis for intern recruiting and managing. 	ESSO/LES
<ul style="list-style-type: none"> Offer internships that meet student needs and university requirements. 	ESSO/LES recruiters
<ul style="list-style-type: none"> Partner with schools to have Early Steps included in rotation for all applicable students, e.g. pediatricians, family practice, RNs, ARNPs, social work, ITDS's, etc. 	LES recruiters/DOE
<ul style="list-style-type: none"> Work with DOE/DOH to improve collaboration in order to provide schools with curriculum components that educate students on child development and the TBPSP approach in addition to medical models. 	(ESSO/DOE/DOH/External Research Partner)
<ul style="list-style-type: none"> Develop and offer incentives to schools for partnerships. 	ESSO/DOH

Strategy 25: Enact policies and procedures as necessary to increase cohesive teaming with the expected benefit of increased trust and mutual respect.

Action Steps	Entity Responsible
<ul style="list-style-type: none"> Use the information from the approach description material developed for strategy 4 as a resource for developing training and policy and procedural documentation on collaboration and teaming. 	External Research Partner/NECTAC
<ul style="list-style-type: none"> Implement a survey with providers and service coordinators to determine teaming patterns/approaches across LES and analyze to see which teaming approaches result in more cohesiveness, trust, and mutual respect. Additional variables essential to positive teaming can be cooperatively developed. 	External Research Partner/NECTAC
<ul style="list-style-type: none"> Complete an analysis to determine categories of teaming approaches and select two to four sites with similar geographies, size, and different approaches (if possible) and gather additional data on teaming. 	External Research Partner/NECTAC
<ul style="list-style-type: none"> Complete a comparison analysis. 	External Research

<ul style="list-style-type: none"> Explore informal support systems that promote teaming using qualitative methods and research literature. 	Partner/NECTAC External Research Partner/LES
<ul style="list-style-type: none"> When defined, require team enrollment processes or a mechanism for identifying who is on an individual provider’s team. 	ESSO/LES
<ul style="list-style-type: none"> Maximize the use of technology to enhance teaming (i.e., Skype, video recording, and assessment by team members). 	State TA workgroup/LES/ESSO
<ul style="list-style-type: none"> Explore the feasibility of allowing co-sessions through Medicaid. <ul style="list-style-type: none"> Provide training for service coordinators on how to use billing practices to increase reimbursement (i.e. bill ITDS as consultation and therapist as therapy through Medicaid). Enact practices to ensure a whole- team understanding of the roles of each person and scope of practice, role of support and direct service providers. Make decisions based on who has the knowledge, skills and abilities to best serve the individual family. 	ESSO/AHCA/LES
<ul style="list-style-type: none"> Identify a way under the state Medicaid plan to pay for team meetings to be more effective and cohesive (i.e., periodic team meetings) . 	ESSO/AHCA
<ul style="list-style-type: none"> Linkage: Strategy 1, 4 	

Strategy 26: Hire/support evaluation and consultation teams to complete evaluations and provide consultation services to LES providers.

Action Steps	Entity Responsible
<ul style="list-style-type: none"> Research best practices for hiring/supporting evaluation and consultation teams. Develop into best practices, consolidate in a manual and disseminate to all LES sites. 	LES/ESSO/External Research Partner
<ul style="list-style-type: none"> Test pilot in more than one area of the state and evaluate effectiveness including a cost/benefit analysis. 	LES/ESSO/External Research Partner
<ul style="list-style-type: none"> Evaluate compliance with best practices and federal laws/rules and program policies. 	ESSO
<ul style="list-style-type: none"> As an alternative, consider assembling a state team of credentialed experts that can provide consultations to LES providers through “telemedicine”. 	ESSO/LES
<ul style="list-style-type: none"> Linkage: Strategies 1 and 17 	

Strategy 27: Use evidence-based parent developmental training, such as the Hanen Approach, as a first service tier prior to direct services for non-medically complex children.

Action Steps	Entity Responsible
<ul style="list-style-type: none"> Develop the policies needed to effectively have a ‘tier’ system for family enrollment, ensuring that the policies are in line with Office of Special Education Programs requirements. 	ESSO/LES
<ul style="list-style-type: none"> Develop the procedures to use an evidence-based developmental parenting curriculum, e.g. the Hanen approach, to maximize the prospect of success for service initiation and integration of care among disparate providers. 	ESSO/LES
<ul style="list-style-type: none"> Train in-house staff, SC and ITDS, with necessary skills to work with families providing services to this first tier of children needing services. Note that this may not be as necessary for families once changes in eligibility criteria are finalized. 	ESSO training unit
<ul style="list-style-type: none"> Linkage: Strategy 1 	

Strategy 28: Evaluate the cost effectiveness and staffing required to have service coordinators operate in dual positions of SC and provider for simpler cases needing less intense services.

Action Steps	Entity Responsible
<ul style="list-style-type: none"> Identify and evaluate LES that currently have dual positions, determine data needed, and collect data systematically. 	ESSO/LES
<ul style="list-style-type: none"> Evaluate efficacy of having dual positions by caseload, client type and other factors. 	ESSO/LES
<ul style="list-style-type: none"> Use more experienced/stronger service coordinators to pilot the dual role responsibility. <ul style="list-style-type: none"> Consider less severe cases without an established condition. Consider families potentially transitioning out of Early Steps services. 	LES
<ul style="list-style-type: none"> Linkage: Strategy 4 	

Strategy 29: Generate a list of empirically supported factors that interfere with parent ability to fully utilize the Early Steps program and develop/implement processes to improve parental capacity to engage in services.

Action Steps	Entity Responsible
<ul style="list-style-type: none"> Complete a comprehensive literature review on the subject of parent engagement. 	External Research Partner
<ul style="list-style-type: none"> Engage parents to discuss what barriers they have encountered and what they see as needed steps to overcome these barriers via focus groups and/or surveys. 	External Research Partner
<ul style="list-style-type: none"> Bring strategies to groups of parents, currently and previously enrolled in Early Steps, to gauge accuracy of messages for training materials. 	External Research Partner/LES
<ul style="list-style-type: none"> Develop service coordinator/provider training that addresses the needs expressed by families. <ul style="list-style-type: none"> Follow up after family has time to digest intake information, with a clear and empathetic communication about the Early Steps system, helping families develop capacity for themselves, writing functional outcomes for <i>family</i> priorities, relationship building, roles of families and providers, etc. 	LES/ESSO/Family Resource Specialists
<ul style="list-style-type: none"> Establish monthly, bi-monthly, or quarterly meetings/conference calls to consistently reinforce the message of Early Steps, its priorities and activities. Make this communication vehicle available for program staff, providers and family members. Agenda items can be established in advance with input from community voices. This strategy needs to be focused on identifying barriers that prevent families from accessing services. 	ESSO
<ul style="list-style-type: none"> Develop more pro-active relationships at the statewide and community level with allied organizations that have the capacity to work cooperatively on advocacy strategy, skills-building and priority setting. Family Café, FDDC, ARC, FCCIT, Children’s Campaign, Children’s Movement of Florida, Children’s Week, and other likely prospective partners should be approached and the relationships discussed and defined. 	LES/Family and Professional Advocates
<ul style="list-style-type: none"> Linkage: Strategies 1, 5, 30 	

Strategy 30: Improve parental level of understanding of the mission and vision of the program to increase buy-in for the program and understanding of their role as an involved team member and partner.

Action Steps	Entity Responsible
<ul style="list-style-type: none"> Develop messages appropriate to parents so they will understand the expectations in the TBPSP approach. Test messages using appropriate methods. Develop into best practices, consolidate in a manual and disseminate to all LES sites. 	<p>ESSO/LES/Research Partner</p>
<ul style="list-style-type: none"> Develop service coordinator/provider training that addresses the needs expressed by families. <ul style="list-style-type: none"> Follow up after family has time to digest intake information, with a clear and empathetic communication about the Early Steps system, helping families develop capacity for themselves, writing functional outcomes for <i>family</i> priorities, relationship building, roles of families and providers, etc. 	<p>LES/ESSO/Parent Resource Specialists</p>
<ul style="list-style-type: none"> Establish mentoring/coaching/peer networking system for families entering program so that experiences with the service system are relevant to every stage of the newly involved parents/families and open dialogue is established. 	<p>Parent Resource Specialists/Family Members</p>
<ul style="list-style-type: none"> Recognize that parent support and education always requires attention to recruiting a fresh crop of involved individuals so that those whose interest wanes as their children age are replaced by new voices. A set of seminars focusing on support and strategic communications should be offered at the community, regional and statewide levels. 	<p>Family advocates/Strategic planner</p>
<ul style="list-style-type: none"> Linkage: Strategies 1 and 29 	

Strategy 31: Develop a process to identify families that are consistently uninvolved, missing appointments, or not benefiting due to limited engagement.

Action Steps	Entity Responsible
<ul style="list-style-type: none"> Develop a rubric for identifying families that appear uninvolved and disengaged. 	<p>LES/ESSO</p>
<ul style="list-style-type: none"> Develop a process for tracking and approaching identified families in a non-threatening and supportive manner. 	<p>LES/ESSO</p>
<ul style="list-style-type: none"> Use material developed in other strategies, e.g. 4, 34 and 35, to promote parent education and involvement. 	<p>LES/ESSO</p>
<ul style="list-style-type: none"> Develop or obtain material for provider training in family 	<p>LES/ESSO/Family Resource</p>

engagement.	Specialists
<ul style="list-style-type: none"> Train providers and service coordinators for family engagement, involvement and support of the family. 	ESSO/LES
<ul style="list-style-type: none"> Develop and implement training on boundaries and safety issues when working in the home with families. 	ESSO/NECTAC/Partnering Agencies
<ul style="list-style-type: none"> Develop a recommended protocol to address no-shows, with training to include strategies to encourage participation. Assess reasons for no-shows to determine underlying causes (e.g., outcome not really what family wants, family overwhelmed). 	ESSO/NECTAC/Partnering Agencies/LES
<ul style="list-style-type: none"> Review Healthy Families' trainings on boundaries, no-shows, engagement. 	Healthy Families/DCF /ESSO/Ounce of Prevention Fund of Florida
<ul style="list-style-type: none"> Linkage: Strategies 1, 4, 29, 30, 34, and 35 	

Strategy 32: Systematically investigate needs and gaps that technology can fill that can reduce costs. Develop a plan to acquire, learn and use the technology appropriately.

Action Steps	Entity Responsible
<ul style="list-style-type: none"> Include use of technology in training on the TBSP for more effective teamwork, such as using video cameras. 	LES/Providers/ESSO
<ul style="list-style-type: none"> Explore need for consent forms for use of recording technology to ensure HIPPA compliance. 	LES/ESSO
<ul style="list-style-type: none"> New technology would require investment that may be difficult due to current technology environments at DOH. Explore the feasibility of this strategy when technology environments change and money is available to invest in new technology beneficial to Early Steps. 	ESSO
<ul style="list-style-type: none"> Investigate ideas for technology purchases and improvements with line staff to ensure that they will use the new technology. If affirmed, develop training and support so staff will become comfortable with the new technology and use it as expected. 	ESSO/LES

Tier 4 Strategies

Strategy 33: Restructure ESSO and LES to have appropriate levels of recommended administrative staff. Consider redirecting salaries to hire more service coordinators, family resource specialists and evaluators.

Action Steps	Entity Responsible
<ul style="list-style-type: none"> Evaluate job responsibilities. Consider reassigning 	ESSO/LES

responsibilities for the optimal efficiency.	
<ul style="list-style-type: none"> Review all areas where there is a duplication of job responsibilities to see if any positions can be consolidated. 	ESSO/LES
<ul style="list-style-type: none"> LES offices should review local staffing patterns to determine optimal staffing for area covered and number served with a goal of creating more service coordinator positions. 	LES
<ul style="list-style-type: none"> CMS restructuring plan is already underway. ESSO states they are already at minimal staffing level. 	ESSO/CMS

Strategy 34: Fund a state-level researcher position that will quickly and accurately respond to the needs of the LES for research, information to support local grant- writing efforts, and other empirical support.

Action Steps	Entity Responsible
<ul style="list-style-type: none"> Collaborate with host agency’s research/grant writing personnel 	ESSO/LES
<ul style="list-style-type: none"> Seek assistance from LES host agencies staff with research and grant writing, If possible, make this a focal point in contract negotiations. 	ESSO
<ul style="list-style-type: none"> Investigate linking with other state agencies with established research staff for some projects or using independent research organizations as support. 	ESSO
<ul style="list-style-type: none"> As a last resort, and only if funds are available, consider using surplus funds from LES who successfully manage their budget to fund this position. 	ESSO/LES

Strategy 35: Work to ensure maximum draw- down of funds to support Early Steps, including current and additional funding.

Action Steps	Entity Responsible
<ul style="list-style-type: none"> Correct perception that available dollars are not being drawn down in their entirety. The Bureau Chief of Early Steps has assured that all funds available to Early Steps are being drawn down. 	ESSO/Early Steps Bureau Chief
<ul style="list-style-type: none"> Consider partnering with DOE Early Education Program (3-5) to address transition services with the possibility of drawing down additional funding. 	ESSO/LES/DOE
<ul style="list-style-type: none"> Using ROI data, seek legislative assistance with accessing additional matching dollars that will allow for increased 	ESSO/FDDC/legislative advocates

federal funds available for draw down.

- Linkages: Strategy 5

Strategy 36: Fund a state-level Medicaid, Medicaid HMO and Private Insurance expert that focuses on policy and best practices to maximize these revenue and reimbursement streams.

Action Steps	Entity Responsible
<ul style="list-style-type: none">• Consider partnering with other DOH/AHCA departments to explore ways to access additional funding sources.	ESSO
<ul style="list-style-type: none">• Consider reassigning responsibilities within ESSO to focus on those working closely with billing to explore additional funding with state Medicaid representatives.	ESSO/ES Bureau Chief
<ul style="list-style-type: none">• Linkage: Strategy 10	

Strategy 37: Ensure IFSP teams have the skills, knowledge and abilities to meet individual child and family needs.

Action Steps	Entity Responsible
<ul style="list-style-type: none">• Develop easily accessible resources on the ESSO Website for evidenced- based practices for working with all children.	ESSO/NECTAC/LES/Providers/ Partner Agencies/External Research Partner
<ul style="list-style-type: none">• Develop formal mechanism for LES to share resources.	ESSO
<ul style="list-style-type: none">• Work with providers to establish mentoring relationships where those who are more proficient in certain areas serve as the provider while other/new providers follow in a consultative role .	LES/Provider recruiters
<ul style="list-style-type: none">• Partner with local colleges and universities to cross- train students using a mentorship/internship programs that allow them to become knowledgeable in many areas of need (Autism, Down syndrome, etc.).	ESSO/LES
<ul style="list-style-type: none">• Linkage: Strategy 27, 29, and 30	

Strategy 38: Develop a resource site for LES to post questions and replies.

Action Steps	Entity Responsible
<ul style="list-style-type: none">• Have technical support designate space on the Early Steps Website for question and answer format (message board, blog, etc.).	ESSO technical support team
<ul style="list-style-type: none">• Have ESSO technical support develop short instructions for this resource site (how to post cases, interacting in the discussion thread) for LES to use.	ESSO technical team

<ul style="list-style-type: none"> • Have technical support provide a discussion thread location so LES can discuss difficult cases. 	ESSO technical support team
<ul style="list-style-type: none"> • Designate appropriate ESSO personnel (those who review cases) to post cases (with names removed) on this site as a resource for all LES. 	Early Steps Bureau Chief
<ul style="list-style-type: none"> • Have LES personnel (directors, SCs, etc.) post difficult cases to which solutions have been developed on this resource site. 	LES directors/Service coordinators

Strategy 39: Develop a statewide medical record and billing system to reduce paperwork and increase consistency of documentation while reducing redundancy.

Action Steps	Entity Responsible
<ul style="list-style-type: none"> • Explore and develop best practices from other states' online medical records/billing systems. 	ESSO
<ul style="list-style-type: none"> • Collaborate with CMS and Medicaid to identify unnecessary duplication of forms. 	ESSO/CMS/Medicaid
<ul style="list-style-type: none"> • Collaborate with other DOH agencies to pool funding to establish a statewide online medical records system. 	ESSO/Early Steps Bureau Chief
<ul style="list-style-type: none"> • Work with technical support to identify fields that can be imported/merged to more efficiently manage time of those inputting data. 	ESSO technical support team/LES technical support personnel/UF Data system/CMS/Medicaid

Strategy 40: Work to systematically assess and improve the current data system, or investigate a new data system if funds can be found and the current system cannot be improved upon.

Action Steps	Entity Responsible
<ul style="list-style-type: none"> • Placed on hold at this time due to uncertainty of future system and rollout of third party administrator and system enhancements, though it has been repeatedly noted that case note inclusion is critical. 	ESSO/Third Party Administrator
<ul style="list-style-type: none"> • Explore using the UF data system to house an electronic case note that automatically calculates the billing unit to bill Medicaid for TCM as an upload to the TPA. 	ESSO technical support team/UF Data system
<ul style="list-style-type: none"> • Explore using the UF data system to house an electronic IFSP to which the demographic and service authorizations can download. 	ESSO technical support team/UF Data system

Strategic Planning and Implementation as a System Approach

A common failing in writing and then implementing a strategic plan is losing sight of the whole while focusing on a series of particulars. The strategies in this plan will likely be implemented systematically a few at a time for the sake of convenience. What becomes lost is the understanding that each of the strategies were derived through an analytic process that makes up a whole, and that working on one strategy will likely impact several other strategies. The potential cross strategy impact is difficult to anticipate and will result in unexpected positive consequences as well as negative effects. The following section on category relationships and linkages highlights relationships between strategies that have been grouped together. The diagrams are shorthand to aid understanding of the empirically supported linkages and will not directly affect implementation; however, they serve as a reminder that strategies are connected, will affect Early Steps as a system of service, and that potential ramifications cannot all be anticipated.

Primary Relationships between Strategies

All strategies were either directly recommended through one of the many methods of data collection completed, or they emerged from the data. Participating individuals had varying levels of understanding about Early Steps and provided strategies or suggestions based on their personal experiences, background and knowledge. There were undoubtedly shared backgrounds, opinions and beliefs that supported commonalities. Though the strategies are defined individually to aid in discussion and implementation of action steps, it would be simplistic to assume that each strategy is independent and that targeting one strategy would in no way affect another.

Figure 1 outlines only the broadest, primary, empirically supported linkages between the 40 strategies. Boxes that are shaded blue are strategies that are placed in the diagram more than once in order to lower the number of relationship arrows needed in the diagram, an attempt to provide a little more clarity to a complicated schematic. Strategies shaded in gold are ones that will need the most outside assistance for completion. Every strategy except for number 35, in the upper right hand corner, is empirically associated with one or more strategies in a direct fashion as determined by analysis of the data. Number 35 is related through mediation of some strategies to others, so it is only at the most direct relationship level, as presented in Figure 1, that it appears unattached.

Figure 1 will not directly assist with implementation, but it does illustrate relationships that aid understanding of the interconnectedness of the strategies and the potential impact on other strategies as individual strategies are satisfied. What the figure does illustrate regarding implementation is that a systemic perspective needs to be maintained; which means that addressing strategies in the suggested tier levels will resonate downward through other tiers, having a greater impact on the system as more is accomplished. A continuous assessment process that evaluates the impact on Early Steps as strategies are accomplished will assist with decisions on which strategy or strategies are targeted next and the overall impact on sustainability improvement.

Figure 1: Primary Data Supported Linkages Between the Final 40 Strategies

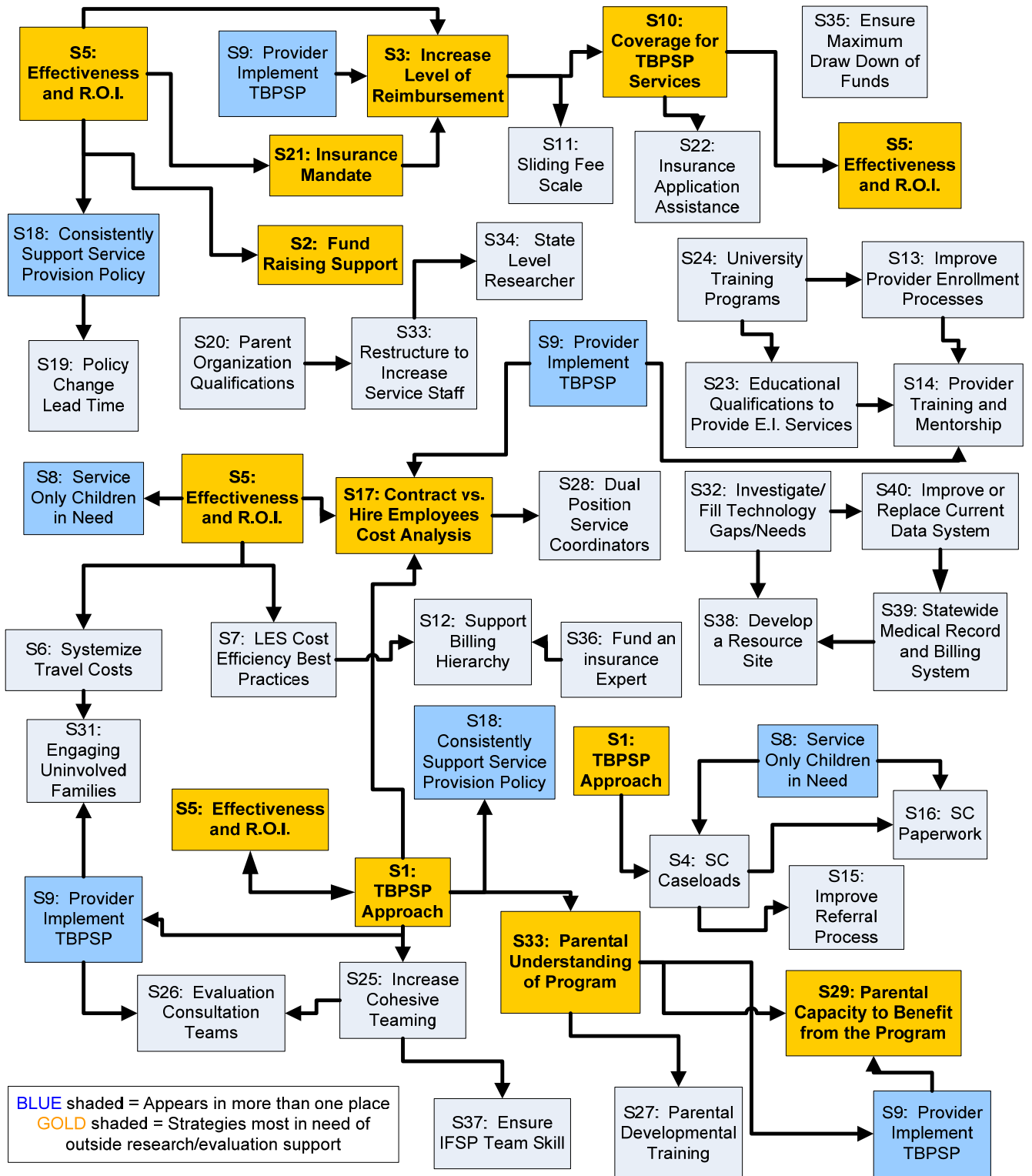

Category Linkages

From the onset of the planning process, different categories of data were created to help explain the large amount of data that was gathered to develop the strategic plan. Careful preliminary research was successful in identifying several key categories that have maintained their integrity as explanatory categories for the data. The categories present from beginning of data collection include cost efficiencies, policy and funding, systems of service (the TBPSP model) and recruitment and retention. An additional category revealed to be of importance during data analysis was data and communication.

Figures 2 through 6 explain the linkages of strategies within each of the five categories noted above. The strategies are numbered in the same sequence as noted in the description of strategies and action steps and have the relevance and feasibility average scores from the relevance and feasibility survey.

Figure 2 reviews the strategies in the cost efficiencies category. Effectiveness and ROI data (strategy 5) are related to additional cost analyses needed to ascertain a solid baseline of what is needed and what

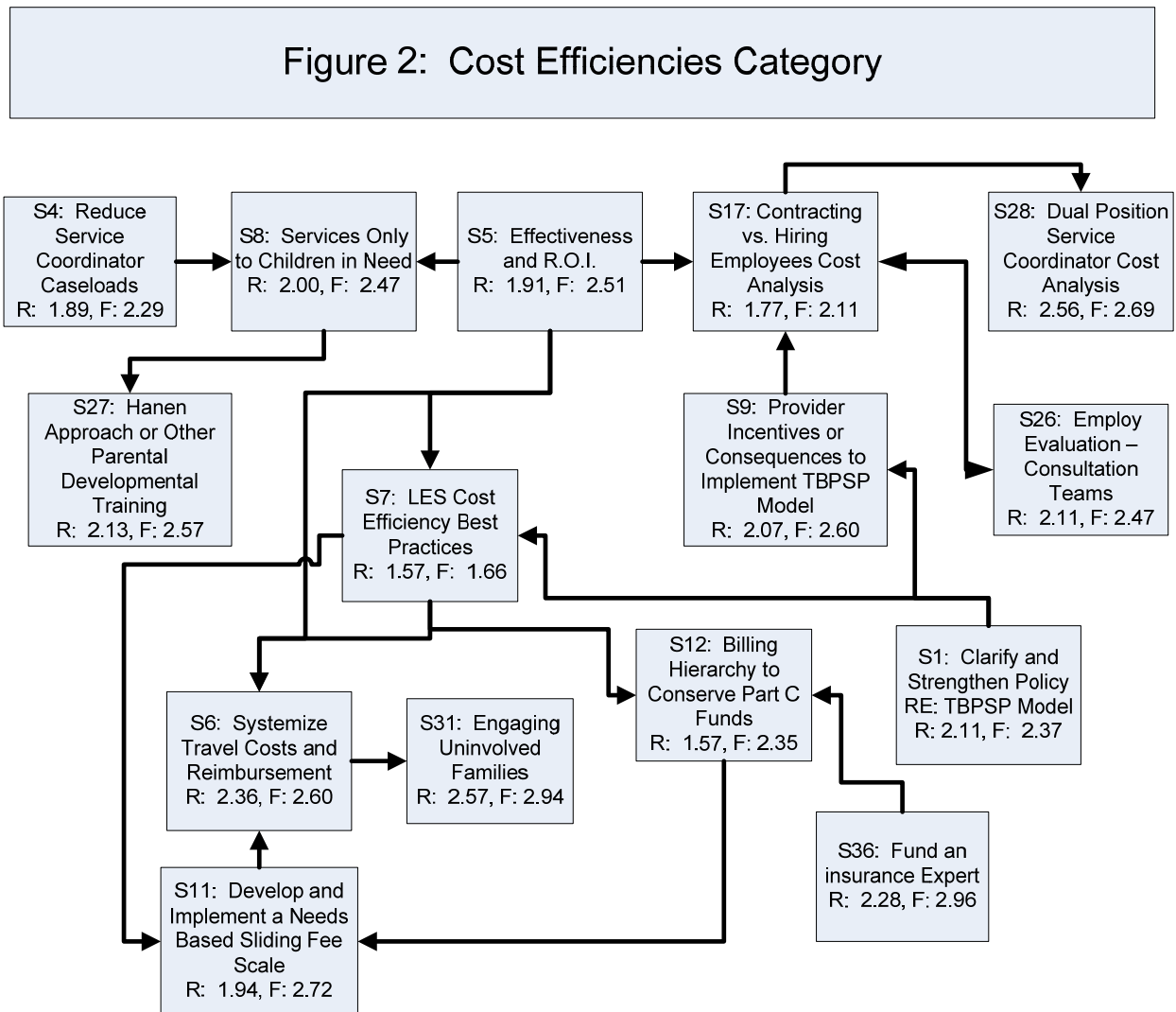

can be cut in expenditures (strategies 17 and 28). Central as well is installing a more rigorous process for identifying when children are no longer in need of services (strategy 8) and triaging children without established conditions into possible developmental parenting programs as a first service tier for assistance and to control the use of resources for more serious cases (strategy 27). Reducing service coordinator caseloads to meet the demands of documentation (strategy 4) is also closely associated with strategy 8.

Establishing best practices for cost efficiency (strategy 7) has the best rating for both relevance and feasibility. Strategy 7 is strongly related to utilizing the payment hierarchy to best advantage, limiting use of Part C funds until the last resort (strategy 12) and containing travel costs (strategy 6), considered one of if not the highest single cost for some LES, and establishing a fee-based scale to offset some program costs. Supporting strategy 7 is clarification of policy and practice for the TBPSP model (strategy 1) that also supports incentivizing the use of the TBPSP model for providers. Linked to travel is engaging disconnected families that often result in provider travel to empty homes (strategy 31).

Figure 3 outlines the relationships of strategies categorized as policy and funding. Established effectiveness and ROI data are central to this category as they support policy and practice implementation and communication (strategies 1 and 18), reimbursement for services under the TBPSP model to families (strategy 3), incentivizing use of the TBPSP model for providers (strategy 9), researching and implementing an insurance mandate for Florida to cover developmental services (strategy 21), and supporting fund raising and other resource development for Early Steps via evidence-based data (strategy 2). Increasing reimbursement is also a central strategy for policy and funding. It is also related to provider incentives (strategy 9) as well as covering more services related to the TBPSP model (strategy 10) and developing a need-based sliding scale fee (strategy 11).

Implementing policy consistently (strategy 18) is supported by establishing consistent policy and practice guidelines (strategy 1), and improved relationships with university training programs (strategy 16). Consistent policy implementation is in turn associated with improved referral procedures (strategy 22), better lead time for implementing policy changes (strategy 19), and establishing minimal qualifications for parent organizations in order to better support Early Steps policy (strategy 20).

Figure 4 outlines the relationships between strategies categorized as system of service/TBPSP approach. Clarifying and strengthening policy and service delivery around the TBPSP approach is central to this category and in turn supports reduced service coordinator caseloads (strategy 4) and paperwork (strategy 16), improved understanding of the model and referrals (strategy 15), provider incentives for providing the approach accurately (strategy 9), improved parental understanding of, and thus engagement in, the approach (strategies 29 and 30), and policies to increase effective teaming (strategies 25, 26, and 37). Consistent program delivery is essential for proving effectiveness, establishing trust in the approach to provider groups, estimating ROI and initiating/maintaining parental involvement.

Figure 3: Policy and Funding Category

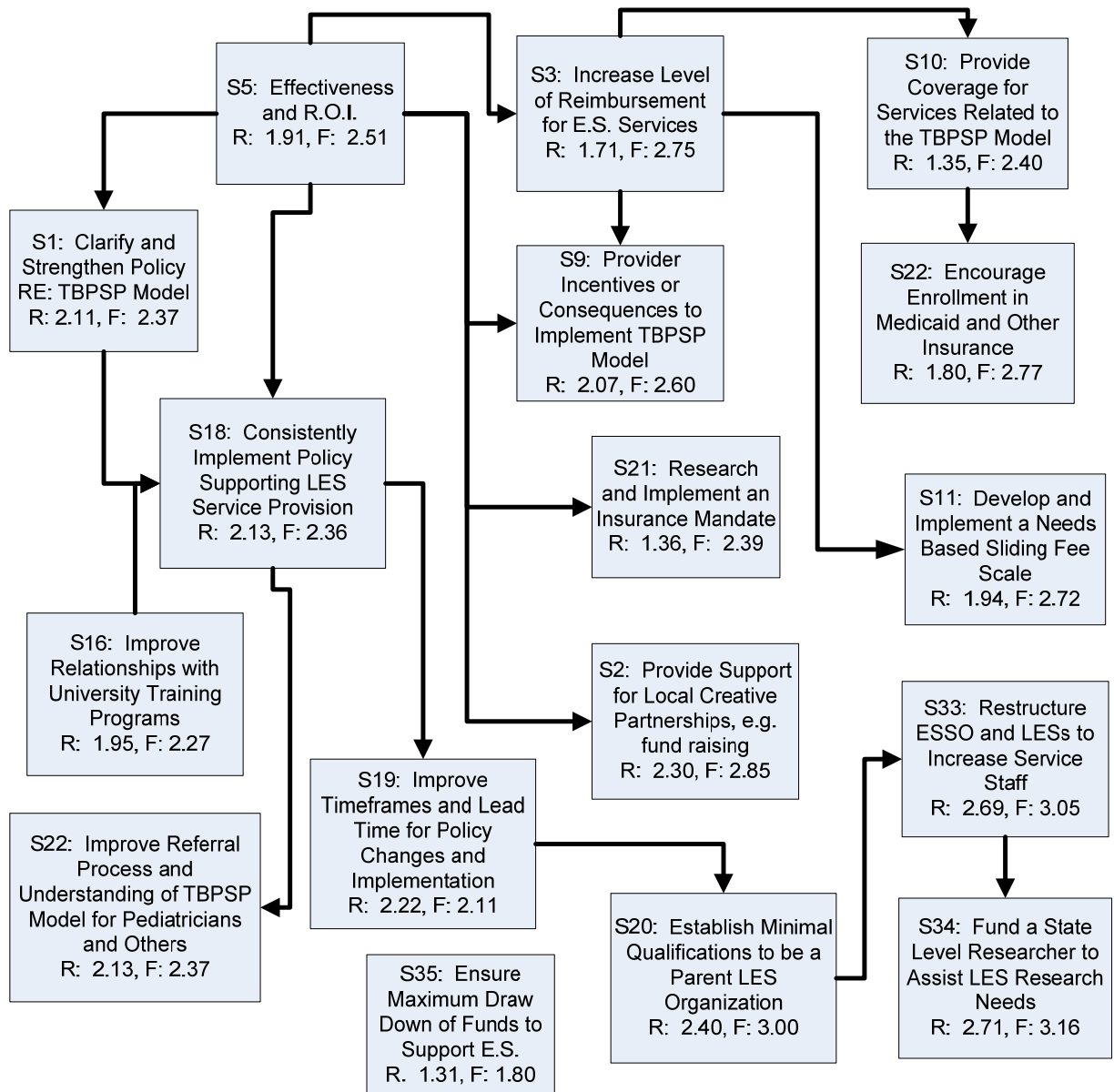
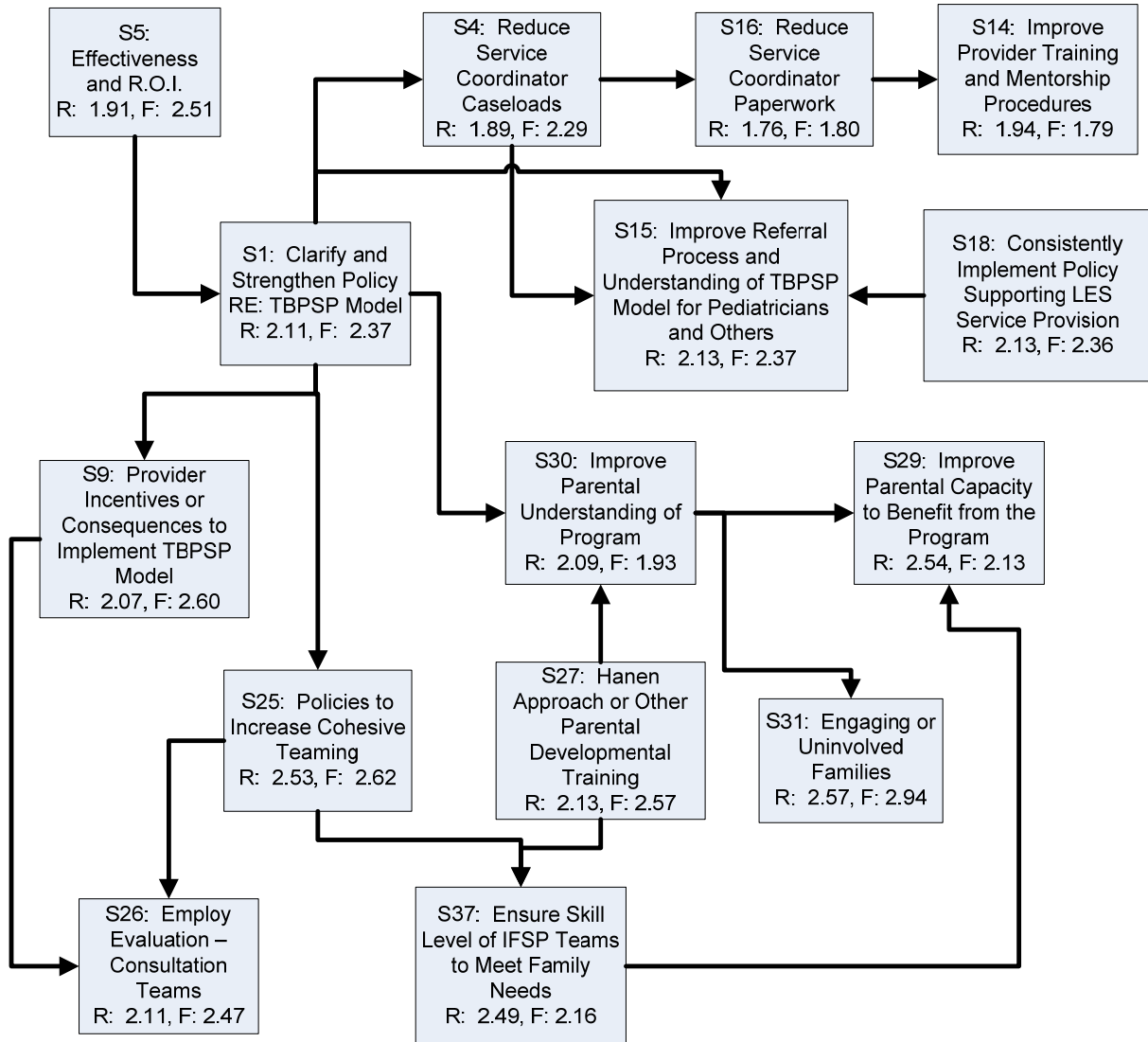

Figure 4: System of Service: Team Based Primary Service Provider (TBPSP) Category



Recruitment and retention of quality providers are important for program delivery and trust by parents and providers in the ability of Early Steps to achieve the changes they are supposed to accomplish. **Figure 5** summarizes the relationships between strategies in the recruitment and retention category. Attracting quality providers needs to start when providers are being trained for their chosen profession (strategy 24). Universities are more likely to support Early Steps if they have evidence that the approach is effective (strategy 5), which in turn will lead to more service coverage and better reimbursement (strategies 10 and 3) that will be an incentive for providers to focus on pediatric service delivery as a career. Further, a reasonable enrollment process (strategy 13) that can provide a livable income earlier rather than later will also convince universities to support Early Steps. Provider enrollment will also be

strengthened as university- trained providers may more readily choose Early Steps. Training and mentorships (strategy 14) are supported by a reasonable enrollment process and in turn provide an incentive for providers to work with Early Steps (strategy 9). Finally, reducing service coordinator caseloads so they can provide more reimbursable direct services to families in need was viewed as critical by Early Steps staff (strategy 4), and that needs to be accompanied by a time expenditure and documentation analysis to reduce redundancy in service coordinator paperwork (strategy 16).

Figure 5: Recruitment and Retention Category

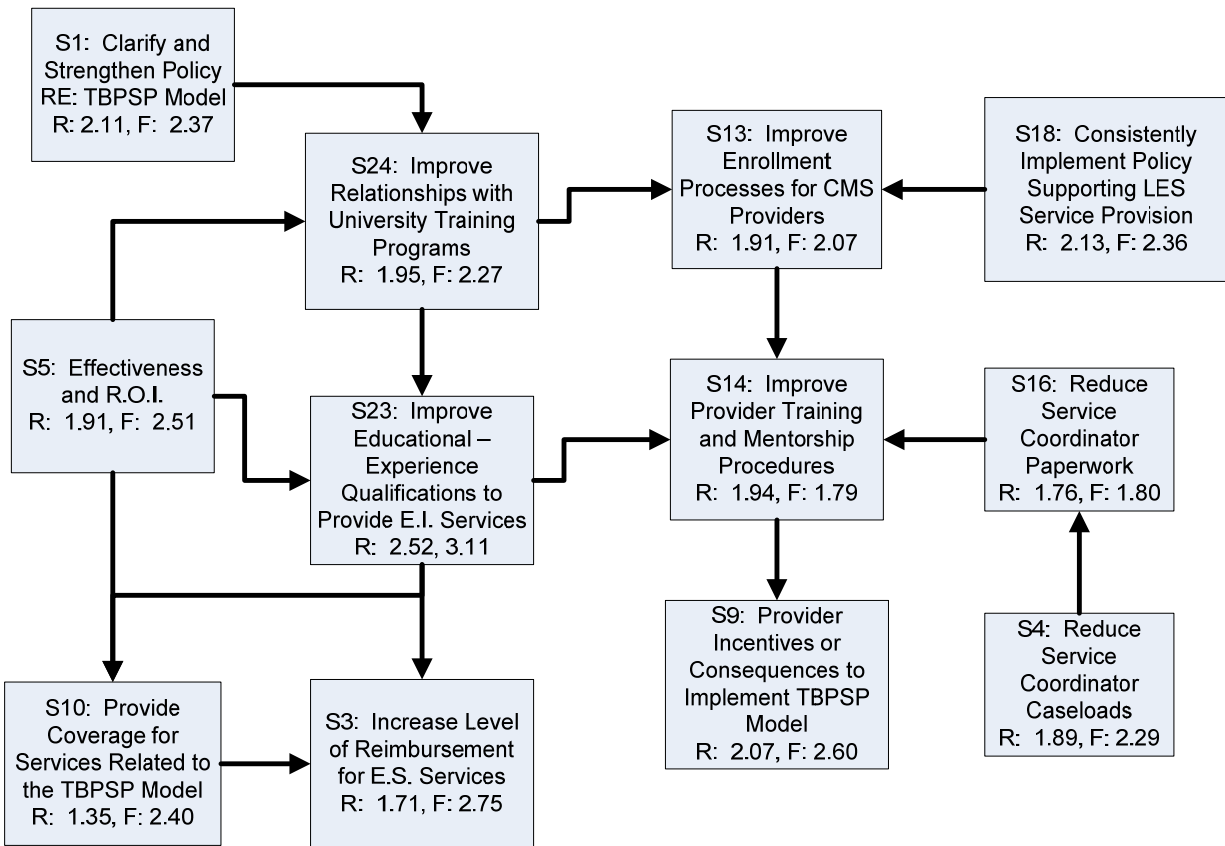

The final category is the data and communication category, which is summarized in **Figure 6**. Technology was consistently viewed as a potential time saver and organizing tool at the LES level (strategy 32). Service coordinators felt they would benefit from technology better suited for use in the field and that allowed electronic signatures to reduce the time spent reconnecting with parents without some other substantive reason for the contact. Resources and plans already in motion regarding technology and the data system pushed them further down in the tier structure than they would be otherwise (strategies 38 and 40). If the plans for the third party administrator and updates to the data system change, then the strategies linked to this category should be re-examined.

Understanding and use of the data system varied widely across respondents. For those with considerable experience with the data system, the view of the system as adequate was considerably higher. The ability to merge data management and billing (strategy 39) is an improvement that the third party administrator is expected to address, though to what degree is yet unknown.

Figure 6: Data/Communication Category

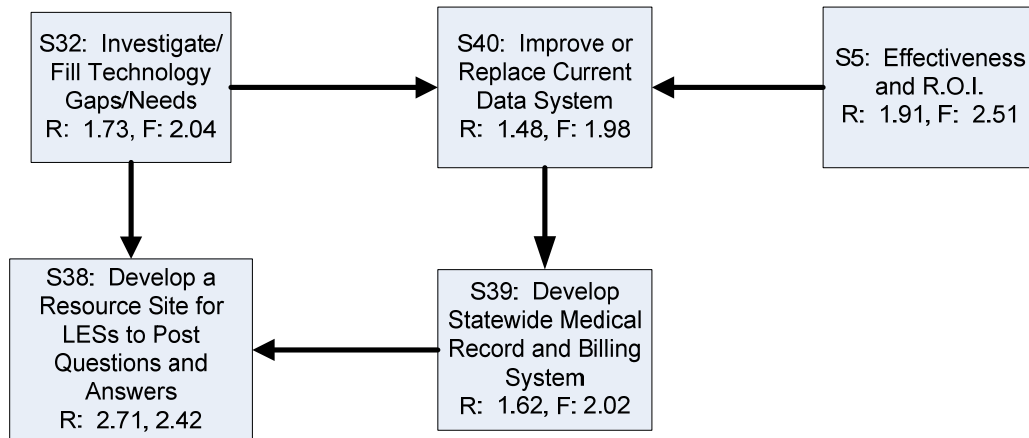

Implementation Elements

Developing a comprehensive implementation plan is beyond the scope of this strategic sustainability plan. However, to help begin the implementation process, the following global, or macro, suggestions for implementing sustainability strategies and monitoring implementation of strategies are offered. Whereas the strategic plan provides the ‘what’ and ‘why’ of changes needed for long-term sustainability, the implementation plan supplies the ‘who, where, when, and how’. Two areas of importance in the strategic planning literature that can interfere with implementation of the plan are resistance to change and a poorly coordinated implementation effort.

Resistance to Change

People are generally uncomfortable leaving patterns and routines to which they have become accustomed. Moving past the challenge of resistance to change is not a simple task. Resistance may come from not just the change being implemented through the sustainability plan, but also from the level of change needed to move Early Steps in the direction that can best serve Florida's children. Because some of the strategies recommended directly impact staffing patterns and job responsibilities at all levels, a natural resistance is expected. Despite these challenges, there are many critical success factors, as described earlier, that Early Steps can cite that will strengthen the program, providing the additional evidence needed to justify to legislators the importance and need of an early intervention

program that appears, in many cases, to be overlooked in favor of more cost-prohibitive treatment programs.

Poorly Coordinated or Minimal Implementation Effort

A natural reaction to budgetary constraints is concern with making prudent financial decisions or, in some cases, not making decisions that could potentially be harmful to the sustainability efforts. Inaction or paralysis can be extremely harmful, especially with the urgency required to implement this plan. Whether it be electing not to take action, or not acting in a timely manner, the long-term potential impact could have compounding negative effects. Components of inaction include misguided actions of straying from specific strategies, or trying to overextend efforts to resolve strategies, each of which can often take more time to correct than is resource reasonable or responsible.

Implementing Strategies

The following are suggestions in a logical order for completing the implementation plan. This is not a comprehensive list and is provided only as a starting point for beginning the implementation planning process:

- Convene an implementation team or work group to monitor, assist and/or actively participate in implementing the strategies in this plan
- Review to ensure that the ‘three C’s’ of strategic planning are present: Commitment, credibility (which has hopefully started with the transparent planning process), and communication
 - Commitment is required by the leadership of ESSO and the LES and should be consistently modeled to all members of the team as well as other participants
 - Continued credibility is earned through representative participation, adherence to the planned process, and clear documentation
 - Develop active and clear communication and feedback pathways as one mechanism to guarantee that the process is transparent and understood by all participants. Progress reporting, accountability and empowerment are key aspects of an implementation plan
- Develop a written implementation plan that includes implementation goals, objectives, activities and monitoring components
 - Participate in in-depth discussions regarding the strategies and their action steps. Finalize a list of goals, objectives, and action steps based on the ones contained in this plan with precise timeframes, sequencing, and person(s) responsible for completion for each strategy as implementation begins for the strategy.
 - Establish a baseline for strategies when appropriate. For instance, establishing or reinforcing a baseline for service coordinator caseloads or paperwork will help to craft appropriate goals and objectives for each strategy
- Make certain that resources are available or can be obtained in a timely fashion for each step of each objective. Plan accordingly to complete what is in reach to avoid being overwhelmed or disappointed. Attempting too much at one time and failing is the number one reason why strategic planning implementation falters and stops before reaching its potential.

- Ensure that documentation of activities to complete strategies is mandatory and that there are concise means to track the processes employed for strategy completion. This is further explained in the next section.

Monitoring and Reporting on Implementation

Monitoring the implementation of the strategic plan is important for several reasons. First, it helps to ensure that your efforts conform to the plan and that participants are actually performing the action steps as intended. Being ‘on track’ is vital for continued enthusiasm and engagement in the implementation process. Second, it is important to make sure the results are aligned with the objectives laid out in the implementation plan. Finally, monitoring allows for corrective action, making the necessary changes along the way before too many resources or too much time is lost. It is important to ‘fine tune’ the strategies and action steps as new data comes in, and monitoring helps this process. Some potential steps for monitoring include:

- Set up a monitoring system that has a central person or persons who are responsible for tracking tasks, timeframes, persons responsible and other key factors, with a system to inform leadership when delays or other issues are found
- Meet monthly, or at an agreed upon timeframe, to discuss progress and make recommendations for redirecting resources, assisting members in need, or other changes
- Make sure that an ‘early warning’ system is in place and operational to detect when resources are being misused or wasted, or when delays in completion are large enough to threaten the process or team morale
- Plan for change and be willing to address changes to strategies, action steps, implementation objectives or steps, and any other factor that may interfere with the successful implementation of the plan
- Review success to detect whether some strategies have been satisfied as a result of other implementation activities and to detect unexpected consequences of activities, whether positive or negative. Maintaining understanding of the plan as a change in systems will assist in accepting changes and their impact over time
- Develop an evaluation component that tracks the implementation process and impacts objectively and uses a quarterly reporting process to assist in detecting issues early.

Review of Strategic Planning Activities

The strategic planning research and development process began as a three-phase project that became a four-phase project as additional research needs were identified and completed. The planning process was a team effort with the primary activities completed by the team at the Ounce of Prevention Fund of Florida (OPFF) and supported by many other organizations and individuals. Two stakeholder groups were critical in completing the strategic plan with the degree of rigor and transparency that was accomplished. **Stakeholder Group 1 (the Early Steps Stakeholder Workgroup)** was required by the FDDC. A small number of individuals were identified, and, following discussions among OPFF, ESSO and the FDDC, other members were identified until a comprehensive group of professionals was selected and agreed to serve. The members of Stakeholder Group 1 and their primary affiliation(s) include:

- Charles Bauer, M.D., LES Director, North Dade County, University of Miami School of Medicine, Miami, Florida
- Laurie Blades, Chief, Children’s Mental Health, Florida Department of Children and Families, Tallahassee, Florida
- Dr. Jeff Brosco, M.D., Ph. D., Child Development and Education Task Force, Florida Developmental Disabilities Council, University of Miami, Miami, Florida
- Kimberly Cole, Parent, Family Resource Specialist, Central Florida LES, Orlando, Florida
- Patty Corder, Program Manager, Pinellas County Early Head Start, Largo, Florida
- Judith Corso, LES Director, Gulf Central, Sarasota Memorial Healthcare System, Sarasota, Florida
- Allison Cruz-Mitchell, Deputy Director of Programs, Florida Developmental Disabilities Council, Tallahassee, Florida
- Karen Denbroeder, Senior Educational Program Director, Florida Department of Education, Tallahassee, Florida
- Martha Harbin, Parent, Advocate, President, Harbin Strategies, Tallahassee, Florida
- Holly Hohmeister, Health Care Manager, Florida Developmental Disabilities Council, Tallahassee, Florida
- Renee Jenkins, Early Steps Policy Director, Children’s Medical Services, Florida Department of Health, Tallahassee, Florida
- April Katine, Program Manager, Child Development and Education Task Force, Florida Developmental Disabilities Council, Tallahassee, Florida
- Rebecca McGuire, Regional Nursing Director, Children’s Medical Services, Big Bend Region, Tallahassee, Florida
- Katy McCullough, Technical Assistance Specialist, National Early Childhood Technical Assistance Center, University of North Carolina, Chapel Hill, North Carolina
- Terri McGarrity, Senior Management Analyst Supervisor, Agency for Persons with Disabilities, Tallahassee, Florida
- Nels McNulty, Provider, Owner/Director, For Kids Only, Inc., Pensacola, Florida
- Amanda Moore, State Inclusion Coordinator, Office of Early Learning, Agency for Workforce Innovation, Jacksonville, Florida
- Jane Murphy, Executive Director, Healthy Start Coalition of Hillsborough County, Tampa, Florida
- Lynn Marie Price, Bureau Chief, Early Steps State Office, Children’s Medical Services, Florida Department of Health, Tallahassee, Florida
- Celeste Putnam, Early Childhood Intervention Consultant, Tallahassee, Florida
- Ellie Schrot, LES Director, Gold Coast, Children’s Diagnostic and Treatment Center, Ft. Lauderdale, Florida
- Kathryn Shea, President/CEO, The Florida Center for Child and Family Development, Sarasota, Florida
- Jared Skok, Parent, Senior Manager, The Blue Foundation for a Healthy Florida, Jacksonville, Florida

- Dr. Patricia Snyder, Chair of Early Childhood Studies, College of Education, University of Florida, Gainesville, Florida
- Gail Underwood, Medical/Health Care Program Analyst, Agency for Health Care Administration, Tallahassee, Florida
- Renee Valletutti, Parent, Council Member, Florida Developmental Disabilities Council, Merritt Island, Florida

Stakeholder Group 1 participated in monthly telephone conference calls to receive status reports, provide input, and discuss the many interim reports they were asked to review.

Stakeholder Group 2 was comprised of the LES directors/coordinators and select designees from each site. It should be noted that three members of Stakeholder Group 1 were also part of Stakeholder Group 2. The responsibilities of Stakeholder Group 2 included:

- Participate in and support several of the data collection methods
- Review and comment on interim documents
- Forward local documents, research, and other information that they thought would be useful or were asked to provide
- Coordinate onsite data collection for the OPFF team.

As noted, there were four phases to the strategic plan developmental process. Each phase consisted of specific methods and deliverables, or interim reports that helped to systematically move the process forward while keeping all parties informed. The methods are described in brief in the next section. The process, or flow, of the four-phase process is summarized in **Figure 7**. The gray boxes in Figure 7 indicate methods and procedures that were in the original strategic planning methodology. The yellow boxes represent additional methods that were added in response to analyses where additional information was vital to develop a comprehensive plan with input from all critical respondents.

Original Data Collection Methods

Large projects require both pre-planning and the flexibility to add, alter, or remove data collection methods depending on the results of interim analyses. For this project, all methods in the original plan were advantageous and were completed according to the plan. These methods included:

- State and Local Early Steps document synthesis
 - Work groups: Data User, Service Coordination, ASD, Provider Issues, and Service Implementation work group information was gathered and analyzed
 - Office of Program Policy and Government Accountability (OPPAGA) reports, state performance plans, budget reports and spreadsheets, and other information were synthesized to understand Early Steps and to extract potential sustainability strategies
- Out-of-state document synthesis— Downloaded or forwarded documents from 12 other states
 - State performance plans, sustainability documents, cost-benefit analyses, service policies/procedures, and other documents were gathered from Colorado, Connecticut, Illinois, Maine, Massachusetts, Missouri, New York, North Carolina, Pennsylvania, Rhode Island, Texas and Virginia

- Interviews with directors of the 12 states' versions of Early Steps
 - 30-60 minutes per phone interview

Figure 7: Phases and Methods for Developing the Early Steps Strategic Sustainability Plan

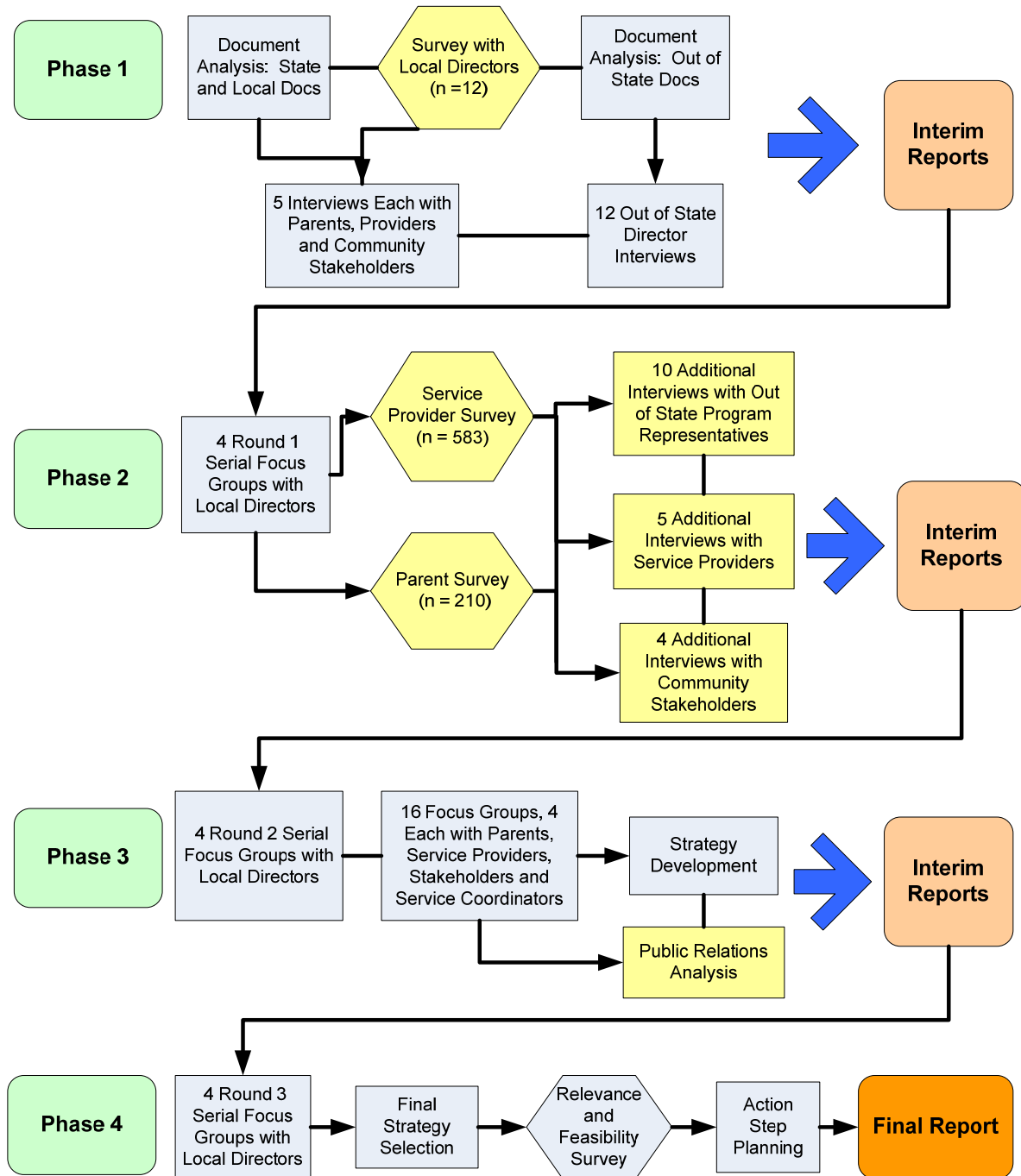

- A semi-structured interview guide was used, interviews were recorded with targeted transcription of the dialogue, and analyzed along with the out- of- state documents
- Interviews with parents, providers and stakeholders
 - 5 each, 15 total, 30-60 minutes per phone interview
 - A semi-structured interview guide was used, interviews were recorded with targeted transcription of the dialogue, and analyzed looking for sustainability strategies and similarities/differences between the three groups to increase understanding of contextual influences on Early Steps
- Serial focus groups with LES directors
 - 3 rounds, 4 focus groups/round, 12 total, 120 minutes per focus group
 - Completed July, August and September 2010 in conference call format
 - Serial focus groups were used to further explore specific areas that data analysis had revealed as potentially critical, to validate results, and to reduce the number of strategies to a manageable level
- On site focus groups
 - 4 focus groups each with providers, stakeholders and parents, 12 total, 120 minutes per focus group
 - Completed August, 2010
 - Average of 10-11 per group for all categories
 - Families were asked primarily to discuss their experiences with Early Steps and to make suggestions for improved service delivery. Providers were asked to discuss their enrollment, service provision, reimbursement, and documentation processes. They were also asked directly what could be done to sustain Early Steps, though the majority of sustainability strategies were extracted from dialogue. The stakeholder groups were made up of individuals with working knowledge of Early Steps and investment in the 0-3 population. They offered unique perspectives on sustainability as directors or other knowledgeable persons that work within the same system as Early Steps
- Strategy development was an internal analytic process that was cyclical and began with the first data collection efforts. Potential strategies were entered into a matrix that indicated the strategy, its origination source, and any explanatory or supporting information required. The analytic process is described in more detail in the following section.
- A Relevance and Feasibility Survey was completed on the final strategies by 56 participants including 14 ESSO respondents, 11 respondents from Stakeholder Group 1, 24 directors, medical directors, or coordinators from LES (Stakeholder Group 2), and 7 additional respondents from LES. Relevance and feasibility were defined for each respondent to improve reliability of responses:
 - *Relevance*: The strategies potential impact on improving positive perception, effectiveness, return on investment, revenues, cost efficiency, service delivery, recruitment and retention of providers, communication, or other factors relevant to the overall sustainability of Early Steps, whether short, intermediate or long-term
 - *Feasibility*: The ability of the strategy to be completed, effected or accomplished given program or resource limitations, the time it will take to implement a strategy

- (understanding that within some strategies multiple steps will be required that will span short to long term), program supports, barriers, and other factors
- A two-day action steps planning meeting was held in October with participants from Stakeholder Group 1, including the three LES directors that were part of Stakeholder Group 2. The group was tasked to develop preliminary action steps for each of the final 40 strategies.

Additional Data Collection Methods

It is rare that the methods developed for a comprehensive research design are adequate throughout the process. Adding methods to meet specific needs ensures that the final product is as comprehensive as possible. The following additional data collection methods were completed:

- A brief literature review of service provision approaches, e.g. transdisciplinary (TBPSP), helps one to better understand the different approaches available to early intervention services and any effectiveness or return on investment data that was available for an approach. A more complete review of the literature will be needed to support the implementation process
- A Director Survey of LES directors/coordinators was completed in Phase 1 of the data collection process in order to gain a better contextual understanding of potential cost efficiency and other information that would influence strategy development. All fifteen regional directors completed the survey. Questions were sectioned into: funding, providers, service delivery, data collection and management, community collaboratives/coalitions, infant mental health and child abuse, family and parent related, policy, advocacy & evaluation questions, and administrative issues
- A provider survey was developed in Phase 2 with online responses via Survey Monkey. There were 583 providers that responded to the survey. Questions were clustered into different sections including: Demographics, primary service area and other questions for sub-analyses, sustainability suggestions, enrollment and retention, service delivery, and reimbursement & funding
- A parent survey was developed in Phase 2 at the same time as the provider survey and online responses were collected via Survey Monkey with 210 families responding. Questions were clustered similar to the provider survey with some changes: Demographics, time in the program and other questions for sub-analyses, referral and enrollment information, services and service delivery, insurance information, and sustainability
- Additional interviews were completed during Phase 2 with in-state stakeholders (4), service providers (5), and out-of-state program representatives (10)
- Focus groups (4) with service coordinators were completed on site at the same time as the original family, provider and stakeholder focus groups (Phase 3). Service coordinators were asked to discuss time and cost efficiencies, enrollment and retention, and other content areas relevant to developing the strategic plan
- An analysis of potential public relations methods and content was completed to assist the ESSO in their effort to design and implement a public relations campaign targeting funders, referral sources (e.g. pediatricians), families, and the community.

Analytic Process

The Meta-Community Information Synthesis (M-CIS), an analytic procedure developed at the Ounce of Prevention Fund, was used to synthesize the data collected for this project. This process combines

meta-analytic and meta-synthesis procedures depending on the objectives and types of data for a project. The process takes advantage of different software packages (e.g. SPSS or SimStat, Atlas.TI or QDA-Miner and WordStat), depending on the needs of the project. The analytic process borrows from grounded theory in that it uses a form of constant comparative analytic processes. The process also supports a data management process that guarantees little to no loss of data as all data are coded and structured for easy retrieval regardless of type or source.

The M-CIS process is flexible and can respond to predetermined as well as emergent questions. An example of each is provided for illustration:

- Predetermined: How consistent is the understanding and application of the TBSP approach across LES?
- Emergent: Was percent of time spent in the natural environment as noted by different disciplines in the provider survey supported by narrative description of time spent, value of or perceived effectiveness of N.E. services?

All meetings, interviews, and focus groups were recorded and strategically transcribed. All documents (obtained and generated) were reviewed to increase understanding of the Early Steps program, to generate strategies, to support potential strategies or to refute potential strategies. The final total of independently generated strategies was 623. All strategies were placed in a matrix and were either kept, combined or eliminated. Duplicates were indicated in a frequency column to ascertain how often the strategy was independently submitted. Identical or near-identical strategies were combined with careful attention to not losing any meaning. Strategies that violated state or federal policy were eliminated. This process reduced the 623 to 138 strategies.

The 138 strategies were shared with the directors in the third round of the serial focus groups and were also sent to ESSO and other key partners. Further discussion reduced the strategies to the 'final 40' as described above, with and without action steps. As previously noted, the strategies were then rated by 56 respondents for relevance to sustainability and feasibility of implementation. The average responses for each category are reproduced below in Table 1.

Part of the analytic process is the development of multiple displays and schematics, several of which are included in this report. Visual representations of data help the research team grasp what are often complicated relationships based on large quantities of data. This process is further validated through checking back into the data independently by members of the team, which also improves reliability of the analytic process through multiple crosschecks. Schematics can be used to describe methodological and analytic processes (e.g. Figure 7) so other researchers can evaluate the rigor of the research effort.

Interim Documents

A series of interim documents were generated. The names of the documents are listed below. The interim documents can be found on the FDDC website (<http://www.fddc.org/>) or can be requested directly through e-mailing Dr. Walby (gwalby@ounce.org).

- Florida Early Steps Document Analysis
- Family, Provider and Stakeholder Interview Analysis
- Out-of-State Document and Interview Combined Analysis

- LES Director Survey Report
- Public Relations Strategies Interim Report
- Family Survey Report
- Provider Survey Report
- LES Serial Focus Group Report
- Focus Group Report (Family, Provider, Service Coordinator, Stakeholder) Combined Report

**Table 1. Early Steps Strategies by Relevance and Feasibility Averages of Strategies by Respondent Group
Ordered Numerically by Final Ordering of Strategies**

Item #	Strategy	All (n=56)		ESSO (n=14)		Stakeholders (n=11)		Directors (n=24)	
		Rel	Fea	Rel	Fea	Rel	Fea	Rel	Fea
Tier 1 Strategies									
1	Develop a definitive definition of the Team Based Primary Service Provider (TBPSP) approach for Florida, clarify (since many LES had different interpretations of what ESSO was communicating), and strengthen state policy requiring the use of the TBPSP model for service delivery	2.11	2.37	1.86	1.71	2.10	2.60	2.00	2.33
2	Provide support for local creative partnerships for resource development, e.g. fund-raising	2.30	2.85	1.62	2.54	2.40	3.20	2.58	2.92
3	Increase level of reimbursement for Medicaid, Medicaid HMOs and Part C providers to better recruit and retain quality providers	1.71	2.75	1.64	3.43	1.64	3.09	1.75	2.33
4	Reduce Service Coordinator caseloads	1.89	2.29	1.86	2.07	1.80	2.60	1.88	2.17
5	Obtain evidence of effectiveness and return on investment specific to Early Steps and its implementation of the PSP model	1.91	2.51	2.14	2.64	1.70	2.20	1.75	2.42
6	Standardize, systematize and provide greater state level support for travel as this is a major cost as well as a barrier for providing services in line with the PSP model	2.36	2.60	2.21	2.29	2.40	2.80	2.33	2.67
7	Investigate the practices and processes of LES that are routinely coming in on or under budget so they can be shared statewide, then develop a plan for sharing and evaluating across the state	1.57	1.66	1.21	1.50	1.64	1.64	1.75	1.79
Tier 2 Strategies									
8	Develop and operationalize empirically- based procedures to ensure that only children in need of services continue to	2.00	2.47	1.86	2.15	2.00	2.40	2.09	2.61

**Table 1. Early Steps Strategies by Relevance and Feasibility Averages of Strategies by Respondent Group
Ordered Numerically by Final Ordering of Strategies**

Item #	Strategy	All (n=56)		ESSO (n=14)		Stakeholders (n=11)		Directors (n=24)	
		Rel	Fea	Rel	Fea	Rel	Fea	Rel	Fea
	receive them								
9	Develop incentives and consequences for providers to correctly implement and support the PSP model	2.07	2.60	1.62	2.15	2.10	2.56	2.13	2.54
10	Work cooperatively with Medicaid, Medicaid HMOs and insurance organizations to provide coverage for services related to the PSP	1.35	2.40	1.43	2.93	1.60	2.50	1.21	2.13
11	Develop and Implement a needs-based sliding scale for Early Steps services that will bill parents based on income	1.94	2.72	1.71	2.36	2.30	2.56	1.96	2.96
12	Improve billing across all LES regions to ensure that the hierarchy of billing is in place and fully utilized so as many alternative payer sources are exhausted before Part C funds are used	1.57	2.35	1.14	1.71	1.70	2.10	1.75	2.75
13	Improve the enrollment process for the CMS provider group (Early Steps), Medicaid, and the LES	1.91	2.07	1.93	2.57	1.60	1.70	2.04	2.00
14	Improve provider training and mentorship procedures and opportunities to enhance provider and service coordinator understanding and acceptance of the TBSP as well as improving service delivery	1.94	1.79	2.00	1.93	1.70	1.89	1.96	1.57
15	Increase training and coaching to improve understanding and comfort of pediatricians and other key referral sources for the TBSP model, especially the referral process	2.13	2.37	2.07	2.00	1.73	2.18	2.17	2.63
16	Reduce Service Coordinator paperwork	1.76	1.80	1.86	1.79	1.60	1.70	1.71	1.63
17	Complete a cost analysis for employing versus contracting providers and enact policies to support provider hiring/contracting practices based on evidence	1.77	2.11	1.69	2.23	1.78	2.00	1.79	2.08
Tier 3 Strategies									

**Table 1. Early Steps Strategies by Relevance and Feasibility Averages of Strategies by Respondent Group
Ordered Numerically by Final Ordering of Strategies**

Item #	Strategy	All (n=56)		ESSO (n=14)		Stakeholders (n=11)		Directors (n=24)	
		Rel	Fea	Rel	Fea	Rel	Fea	Rel	Fea
18	Strengthen and consistently implement policy for ESSO to support the LES decisions on service provision	2.13	2.36	1.92	1.92	2.00	2.40	2.09	2.35
19	Improve timeframes for policy development and implementation to improve planning and projecting for possible consequences	2.22	2.11	2.21	2.21	2.30	2.10	2.21	2.08
20	Establish minimal qualifications to be a parent organization for LES. Consider relocating LES whose parent organization does not meet minimal qualifications	2.40	3.00	1.64	2.57	2.40	3.10	2.71	3.17
21	Develop the steps for, then implement, strategies to develop an insurance mandate for Florida	1.36	2.39	1.57	2.93	1.55	2.64	1.13	2.13
22	Encourage enrollment in Medicaid for families that are eligible and, when mandatory health insurance begins, assist any family without insurance in finding insurance	1.80	2.77	1.71	2.50	2.09	3.09	1.61	2.71
23	Overhaul/improve the education and experience qualifications for providing Early Intervention services	2.51	3.11	2.43	3.36	2.60	3.00	2.46	3.08
24	Establish relationships with university training programs in the state to influence curriculum and provide practicum and internship opportunities with Early Steps and to train/inform for the TBSP model	1.95	2.27	1.93	2.14	1.90	2.00	2.04	2.54
25	Enact policies/procedures necessary to increase cohesive teamwork with the expected benefit of increased trust and mutual respect	2.53	2.62	2.64	2.50	2.00	2.10	2.46	2.75
26	Hire/support evaluation and consultation teams to complete evaluations and provide consultation services to LES providers	2.11	2.47	2.43	2.71	2.50	2.50	1.87	2.38
27	Utilize evidence-based parent developmental training, such as the Hanen Approach, as a FIRST TIER prior to direct services for non-medically complex children	2.13	2.57	2.29	3.21	2.36	2.82	1.96	2.17

**Table 1. Early Steps Strategies by Relevance and Feasibility Averages of Strategies by Respondent Group
Ordered Numerically by Final Ordering of Strategies**

Item #	Strategy	All (n=56)		ESSO (n=14)		Stakeholders (n=11)		Directors (n=24)	
		Rel	Fea	Rel	Fea	Rel	Fea	Rel	Fea
28	Evaluate the cost effectiveness and staffing required to have service coordinators operate in dual positions of service coordinator and provider for simpler cases needing less intense services	2.56	2.69	2.07	2.14	2.30	2.70	2.88	2.83
29	Generate a list of empirically supported factors that interfere with parent ability to fully utilize the Early Steps program and develop/implement processes to improve parental capacity to engage in services	2.54	2.13	2.62	2.23	1.89	2.00	2.71	2.21
30	Improve parental level of understanding of the mission and vision of the program to increase buy-in for the program and understanding of their role as an involved team member and partner	2.09	1.93	1.93	1.93	1.90	1.90	2.25	1.92
31	Develop a process to identify families that are consistently uninvolved, missing appointments, or not benefiting due to limited engagement	2.57	2.94	2.50	2.93	2.00	2.33	2.96	3.25
32	Systematically investigate technology needs, gaps that technology can fill that will reduce costs, and develop a plan to acquire, train and utilize the technology appropriately	1.73	2.04	2.07	2.43	1.70	1.80	1.54	1.96
Tier 4 Strategies									
33	Restructure ESSO and LES to have appropriate levels of recommended administrative staff. Consider redirecting salaries to hire more service coordinators, family service coordinators, and evaluators	2.69	3.05	2.00	2.57	2.60	3.10	3.17	3.29
34	Fund a state level researcher position that will quickly and accurately respond to the needs of the LES for research, information to support local grant writing efforts, and other	2.71	3.16	2.93	3.79	2.50	2.80	2.75	3.04

**Table 1. Early Steps Strategies by Relevance and Feasibility Averages of Strategies by Respondent Group
Ordered Numerically by Final Ordering of Strategies**

Item #	Strategy	All (n=56)		ESSO (n=14)		Stakeholders (n=11)		Directors (n=24)	
		Rel	Fea	Rel	Fea	Rel	Fea	Rel	Fea
	empirical support								
35	Work to ensure maximum draw down of funds to support Early Steps, including current and additional funding	1.31	1.80	1.31	2.00	1.18	2.00	1.21	1.54
36	Fund a state level Medicaid, Medicaid HMO and Private Insurance expert that focuses on policy & best practices to maximize these dollars and reimbursement moneys	2.38	2.96	2.29	2.86	3.00	3.40	2.21	2.91
37	Ensure IFSP teams have the skills, knowledge and abilities to meet the individual child and families' needs	2.49	2.16	2.43	2.43	2.60	2.30	2.58	2.08
38	Develop a resource site for LES to post questions and replies	2.71	2.42	2.64	2.29	2.60	2.50	2.83	2.58
39	Develop a statewide medical record and billing system to reduce paperwork and increase documentation consistency while reducing redundancy	1.62	2.02	1.79	2.29	1.60	2.00	1.50	1.88
40	Work to systematically assess and improve the current data system or investigate a new data system if funds can be found and the current system cannot be improved	1.48	1.98	1.64	2.14	1.45	2.27	1.29	1.79